



# VAN EQUIPMENT

The perfect solution  
for a mobile workspace!

Royal Tool Control Ltd. - +44 (0)114 2441411 - [sales@royaltool.co.uk](mailto:sales@royaltool.co.uk) - [www.royaltool.co.uk](http://www.royaltool.co.uk)



Supplied by:-

Royal Tool Control Ltd.  
Amberley Court, Bold Street  
Sheffield, UK, S9 2LQ  
+44(0)114 2441411  
[www.royaltool.co.uk](http://www.royaltool.co.uk)

Royal Tool Control Ltd. - +44 (0)114 2441411 – [sales@royaltool.co.uk](mailto:sales@royaltool.co.uk) – [www.royaltool.co.uk](http://www.royaltool.co.uk)

# VAN EQUIPMENT IN DANISH QUALITY

## FLEXIBLE - DURABLE - ECONOMIC

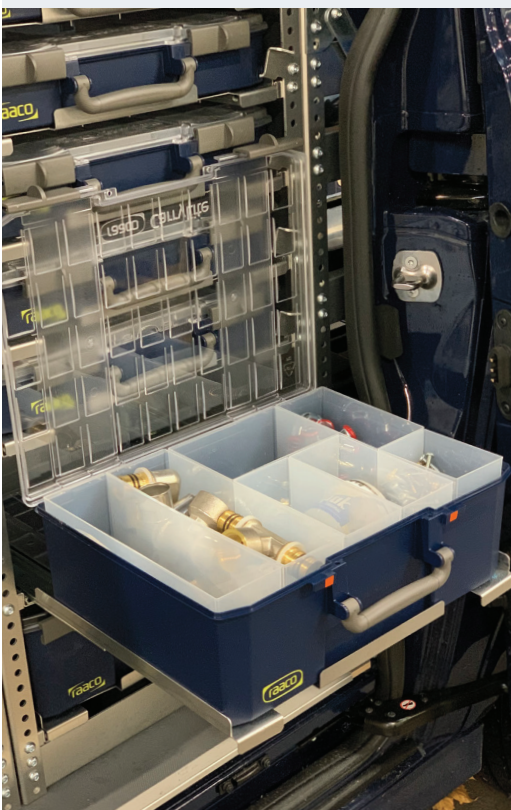

# MODEL OVERVIEW

Find your specific van in the overview. Look up on the summary page for your van. Which specific needs do you have for storage in your van? Do you have a lot of small items, choose set or modules containing 4-800 shelf drawers. Do you need to store many medium or large sized items, therefore choose the bigger shelf drawers such as 6-1100 and 8-2000.

In the model overview for your specific van, you will find easy instructions for the equipment, matching your needs.

The overview and the interior design suggestions are based on a range of standard modules with the abbreviation SS.

SS – Standard system is universal and covers most needs for storage in the mobile workshop

ES – EL-System is a standard module customized for the electrician

VS – VVS-system is a standard module customized for the plumber

AS – Alternative System is developed for the craftsman, who needs a great number of drawers or without boxes and drawers.

But - with raaco van equipment you are not tied to pick "a standard solution". If the standard systems do not match your needs, you are free to choose single modules or to customize your very own solution which matches your specific needs.

## CITROËN PAGE

Berlingo - L1	6
Berlingo - L2	10
Jumpy - L2 (M)	12
Jumpy - L3 (XL)	18
Jumper - L1/H1	20
Jumper - L2/H2	28
Jumper - L3/H2	34

## DACIA

Dokker - L1	6
-------------	---

## FIAT

Doblò - L1	6
Doblò - L2	10
Fiorino - L1	8
Talento - L1/H1	14
Talento - L2/H1	18
Ducato - L1/H1	20
Ducato - L2/H1	26
Ducato - L2/H2	28
Ducato - L3/H2	34

## FORD

Connect - L1	6
Connect - L2	10
Courier - L1	8
Custom - L1/H1	14
Custom - L1/H2	16
Custom - L2/H1	24
Custom - L2/H2	20
Transit 2T - L2/H2	28
Transit 2T - L2/H3	28
Transit 2T - L3/H2	30
Transit 2T - L3/H3	30
Transit 2T- L4/H3	38

## IVECO

Daily - 9m <sup>3</sup> - L2/H1	26
Daily - 10,8 m <sup>3</sup> - L2/H2	30
Daily - 12 m <sup>3</sup> - L3/H2	34
Daily - 13,4 m <sup>3</sup> - L3/H3	36

## MAN

TGE - L3/H3	30
TGE - L4/H3	38
TGE - L5/H3	38

## MERCEDES

Citan - L1	6
Vito - L1	12
Vito - L2	14
Vito - L3	24
Sprinter - L1/H1	20
Sprinter - L1/H2	22
Sprinter - L2/H1	32
Sprinter - L2/H2	34
Sprinter - L3/H2	37
Sprinter - L3/H3	38
Sprinter - L4/H2	37
Sprinter - L4/H3	38

## NISSAN

Townstar - L1	6
Primastar - L1	12
Primastar - L2	18
Interstar - L1/H1	16
Interstar - L1/H2	16
Interstar - L2/H2	28
Interstar - L3/H2	34

## OPEL

Combo - L1	6
Combo - L2	10
Vivaro - L1	10
Vivaro - L2	12
Vivaro - L3	18
Movano - L1/H1	20
Movano - L2/H1	26
Movano - L2/H2	28
Movano - L3/H2	34
Movano - L3/H3	36

## PEUGEOT

Partner - L1 (M)	6
Partner - L2 (XL)	10
Expert - L2 (M)	12
Expert - L3 (XL)	18
Boxer - L1/H1	20
Boxer - L2/H1	26
Boxer - L2/H2	28
Boxer - L3/H2	34

## RENAULT

Kangoo - L1	6
Kangoo Maxi - L2	10
Traffic - L1/H1	14
Traffic - L2/H1	18
Master - L1/H1	16
Master - L1/H2	16
Master - L2/H2	28
Master - L2/H3	28
Master - L3/H2	34
Master - L3/H3	34

## TOYOTA

ProAce City - L1	6
ProAce City - L2	10
Proace - L1	10
ProAce - L2	12
ProAce - L3	18

## VOLKSWAGEN

ID Buzz - L1	10
Caddy - L1	6
Caddy Maxi - L2	10
Transporter - L1/H1	12
Transporter - L1/H2	12
Transporter - L2/H1	24
Transporter - L2/H2	24
Crafter - L3/H2	26
Crafter - L3/H3	30
Crafter - L4/H3	37
Crafter - L5/H3	37



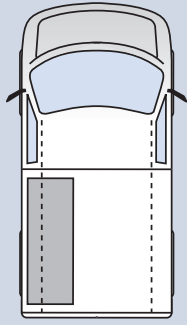

### The shelving position in the van

The depth of all modules is 380 mm.

Adjustment of end walls may be necessary.

### Fits the following models

- Citroën Berlingo L1
- Dacia Dokker L1
- Fiat Doblo L1
- Ford Connect L1
- Mercedes Citan L1
- Nissan Townstar L1
- Opel Combo L1
- Peugeot Partner L1 (M)
- Renault Kangoo L1
- Toyota Proace City L1
- Volkswagen Caddy L1

### MODEL S7 – alternative

Unassembled EAN: 187060

Assembled EAN: 183062

Content: 8 pcs. Shelf bin 4-800  
2 pcs. Alu drawers  
1 pcs. Perforated panel

Total weight: 32,1 kg

**S7** weight 32,1 kg

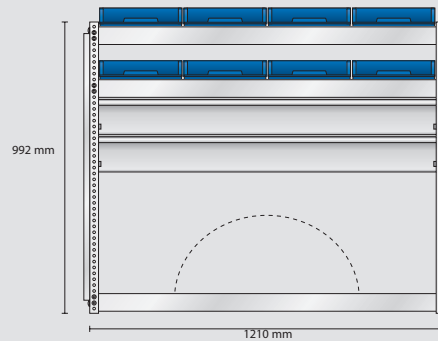

Unassembled EAN: 187060

Assembled EAN: 183062

**S9** weight 18,5 kg

### MODEL S9 – alternative

Unassembled EAN: 187084

Assembled EAN: 183086

Content: 1 pcs. Perforated panel

Total weight: 18,5 kg

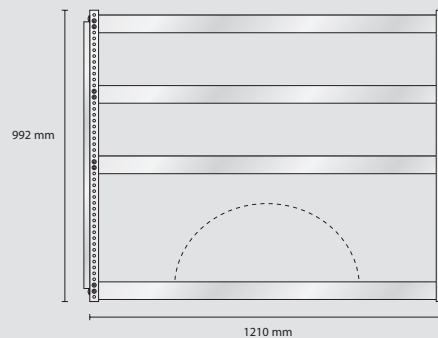

Unassembled EAN: 187084

Assembled EAN: 183086

## MODEL S1 – standard

Unassembled EAN: 187008

Assembled EAN: 183000

Content: 10 pcs. Shelf bin 6-1100  
4 pcs. Shelf bin 8-2000  
1 pcs. Perforated panel

Total weight: 28,5 kg

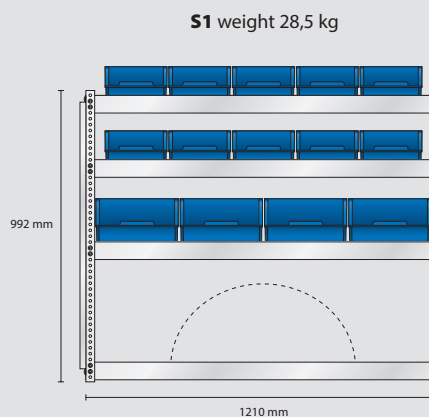

Unassembled EAN: 187008

Assembled EAN: 183000

## MODEL S3 – electrician

Unassembled EAN: 187022

Assembled EAN: 183024

Content: 1 pcs. Shelf bin 4-800  
12 pcs. Shelf bin 5-600  
2 pcs. CarryLite 80-15  
1 pcs. Perforated panel

Total weight: 27,9 kg

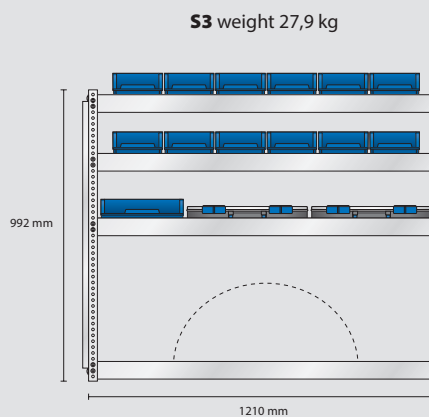

Unassembled EAN: 187022

Assembled EAN: 183024

## MODEL S5 – plumber

Unassembled EAN: 187046

Assembled EAN: 183048

Content: 12 pcs. Shelf bin 4-800  
1 pcs. Perforated panel

Total weight: 25,7 kg

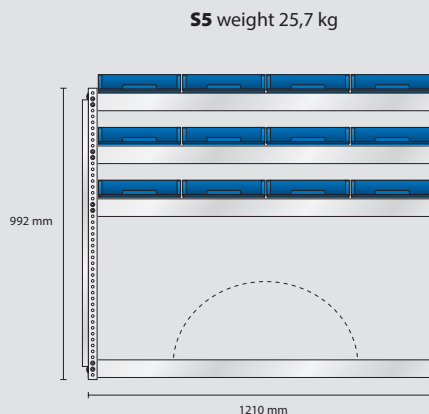

Unassembled EAN: 187046

Assembled EAN: 183048

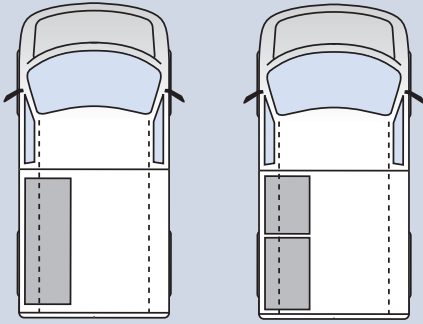

### The shelving position in the van

The depth of all modules is 380 mm.

Adjustment of end walls may be necessary.

### Fits the following models

- Fiat Fiorino L1
- Ford Courier L1

## MODEL S218 – alternative

Unassembled EAN: 189583

Assembled EAN: 189606

Content: 5 pcs. Shelf bin 5-600  
 4 pcs. Shelf bin 6-1100  
 2 pcs. Alu drawers  
 1 pcs. Perforated panel

Total weight: 28,9 kg

**S218** weight 28,9 kg

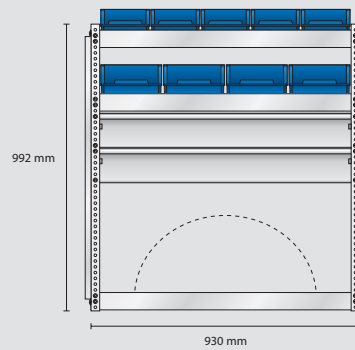

Unassembled EAN: 189583

Assembled EAN: 189606

## MODEL S219 – alternative

Unassembled EAN: 189590

Assembled EAN: 189613

Content: 1 pcs. Perforated panel

Total weight: 16,2 kg

**S219** weight 16,2 kg

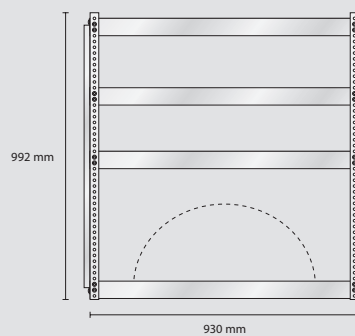

Unassembled EAN: 189590

Assembled EAN: 189613



## MODEL SS39 – standard

Unassembled EAN: 189521

Assembled EAN: 189538

Content: 8 pcs. Shelf bin 4-800  
1 pcs. CarryLite 55-25/2  
5 pcs. CarryLite 80-15  
1 pcs. CarryLite 150-9

Total weight: 44,3 kg

S6 weight 18,7 kg

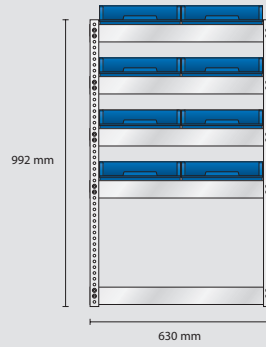

Unassembled EAN: 187053

Assembled EAN: 183055

S292 weight 25,6 kg



Unassembled EAN: 185752

Assembled EAN: 188708

## MODEL ES40 – electrician

Unassembled EAN: 189545

Assembled EAN: 189552

Content: 6 pcs. Shelf bin 4-800  
2 pcs. Shelf bin 8-2000  
1 pcs. CarryLite 55-25/2  
5 pcs. CarryLite 80-15  
1 pcs. CarryLite 150-9

Total weight: 45,1 kg

S4 weight 19,5 kg

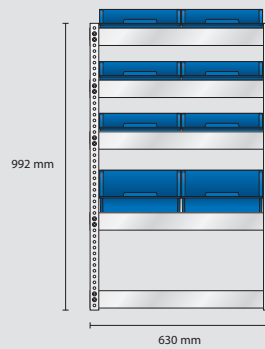

Unassembled EAN: 187039

Assembled EAN: 183031

S292 weight 25,6 kg

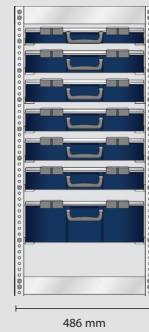

Unassembled EAN: 185752

Assembled EAN: 188708

## MODEL VS41 – plumber

Unassembled EAN: 189569

Assembled EAN: 189576

Content: 6 pcs. Shelf bin 5-600  
2 pcs. Shelf bin 8-2000  
1 pcs. CarryLite 55-25/2  
5 pcs. CarryLite 80-15  
1 pcs. CarryLite 150-9

Total weight: 42,5 kg

S2 weight 16,9 kg

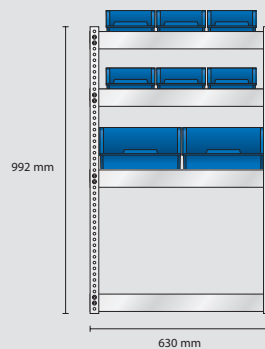

Unassembled EAN: 187015

Assembled EAN: 183017

S292 weight 25,6 kg



Unassembled EAN: 185752

Assembled EAN: 188708

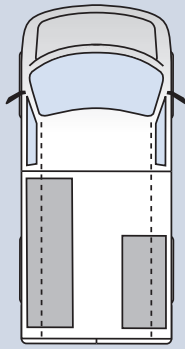

### The shelving position in the van

The depth of all modules is 380 mm.  
Adjustment of end walls may be necessary.

### Fits the following models

- Citroën Berlingo L2
- Fiat Doblo L2
- Ford Connect L2
- Opel Combo L2
- Opel Vivaro L1
- Peugeot Partner L2 (XL)
- Renault Kangoo Maxi L2
- Toyota Proace City L2
- Toyota Proace L1
- Volkswagen ID Buzz L1
- Volkswagen Caddy Maxi L2

### MODEL AS5 – alternative

Unassembled EAN: 186131

Assembled EAN: 182133

Content: 21 pcs. Shelf bin 5-600  
4 pcs. Shelf bin 6-1100  
5 pcs. Shelf bin 8-2000  
2 pcs. Alu drawers  
3 pcs. Perforated panels

Total weight: 66,3 kg

**S20** weight 36 kg

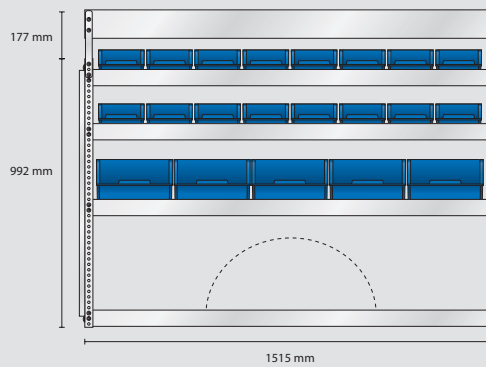

Unassembled EAN: 187169

Assembled EAN: 183161

**S27** weight 30,3 kg

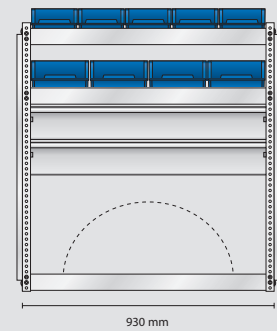

Unassembled EAN: 187268

Assembled EAN: 183260

### MODEL AS6 – alternative

Unassembled EAN: 186148

Assembled EAN: 182140

Content: 3 pcs. Perforated panels

Total weight: 42,2 kg

**S28** weight 24,6 kg

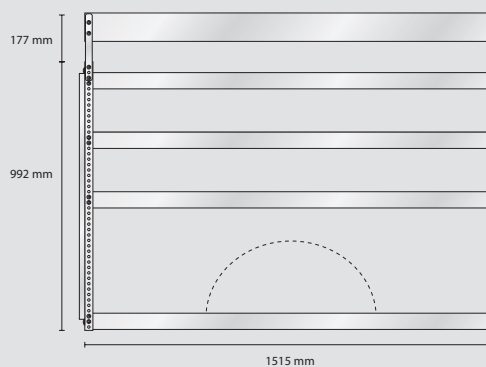

Unassembled EAN: 187275

Assembled EAN: 183277

**S29** weight 17,6 kg

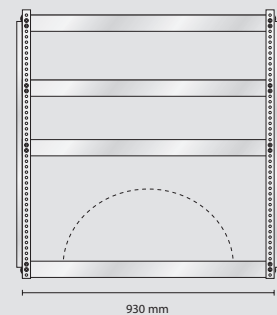

Unassembled EAN: 187282

Assembled EAN: 183284

## MODEL SS3 – standard

Unassembled EAN: 186100  
 Assembled EAN: 182102

Content: 21 pcs. Shelf bin 5-600  
 4 pcs. Shelf bin 6-1100  
 8 pcs. Shelf bin 8-2000  
 2 pcs. Perforated panels

Total weight: 59,6 kg

S20 weight 36 kg

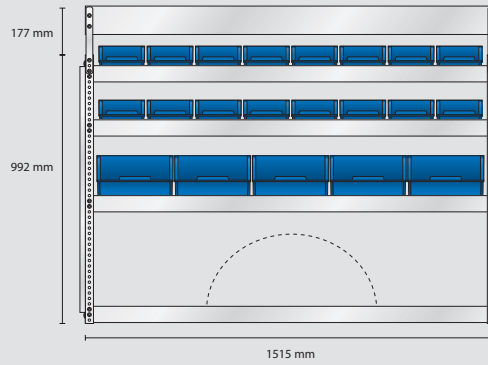

Unassembled EAN: 187169  
 Assembled EAN: 183161

S21 weight 23,6 kg

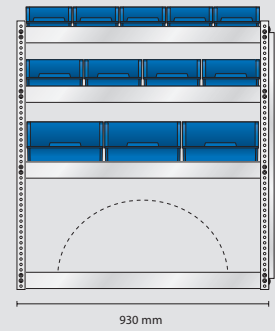

Unassembled EAN: 187206  
 Assembled EAN: 183208

## MODEL ES3 – electrician

Unassembled EAN: 186117  
 Assembled EAN: 182119

Content: 10 pcs. Shelf bin 4-800  
 6 pcs. Shelf bin 5-600  
 4 pcs. Shelf bin 6-1100  
 5 pcs. CarryLite 80-15  
 2 pcs. Perforated panels

Total weight: 60,6 kg

S22 weight 36,4 kg

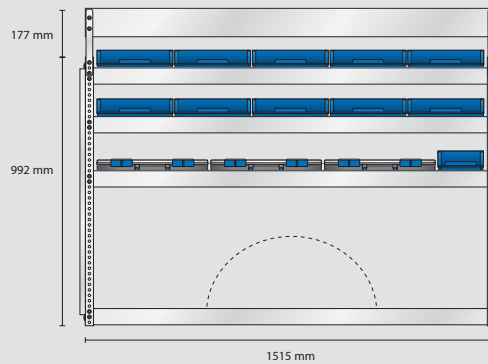

Unassembled EAN: 187213  
 Assembled EAN: 183215

S23 weight 24,2 kg

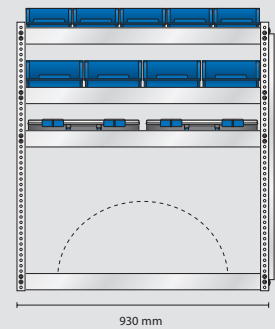

Unassembled EAN: 187220  
 Assembled EAN: 183222

## MODEL VS3 – plumber

Unassembled EAN: 186124  
 Assembled EAN: 182126

Content: 24 pcs. Shelf bin 4-800  
 1 pcs. Alu drawer  
 2 pcs. Perforated panels

Total weight: 60,1 kg

S24 weight 33,6 kg

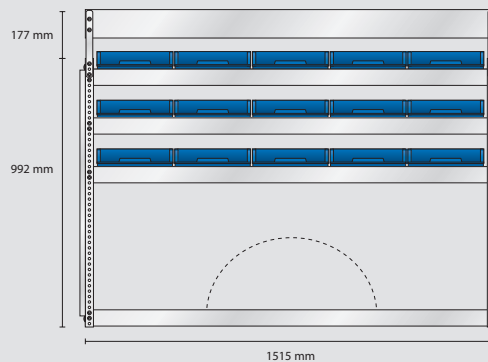

Unassembled EAN: 187237  
 Assembled EAN: 183239

S25 weight 26,5 kg

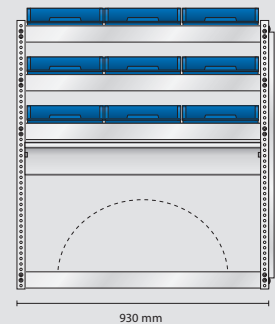

Unassembled EAN: 187244  
 Assembled EAN: 183246

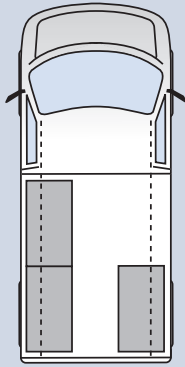

### The shelving position in the van

The depth of all modules is 380 mm.  
Adjustment of end walls may be necessary.

### Fits the following models

- Citroën Jumpy L2 (M)
- Mercedes Vito L1
- Nissan Primastar L1
- Opel Vivaro L2
- Peugeot Expert L2 (M)
- Toyota Proace L2
- Volkswagen Transporter L1/H1
- Volkswagen Transporter L1/H2

### MODEL AS27 – alternative

Unassembled EAN: 185691  
Assembled EAN: 182652

Content: 6 pcs. Shelf bin 4-800  
5 pcs. Shelf bin 5-600  
4 pcs. Shelf bin 6-1100  
9 pcs. Shelf bin 8-2000  
3 pcs. Alu drawers  
3 pcs. Perforated panels

Total weight: 84,2 kg

**S189** weight 26,2 kg

**S39** weight 30,3 kg

**S40** weight 28 kg

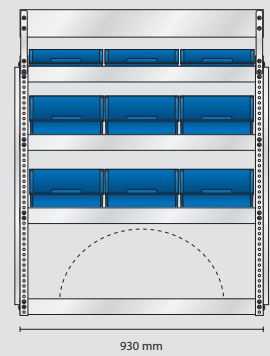
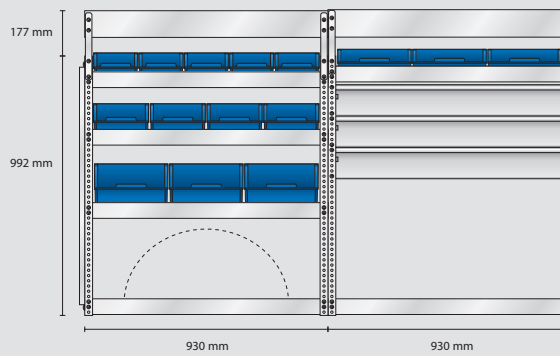

Unassembled EAN: 185660  
Assembled EAN: 184625

Unassembled EAN: 187381  
Assembled EAN: 183383

Unassembled EAN: 187398  
Assembled EAN: 183390

### MODEL AS28 – alternative

Unassembled EAN: 185707  
Assembled EAN: 182669

Content: 3 pcs. Perforated panels

Total weight: 56,1 kg

**S190** weight 18,8 kg

**S126** weight 17,4 kg

**S127** weight 20,2 kg

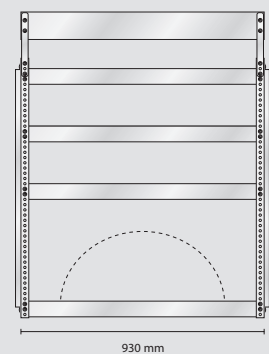
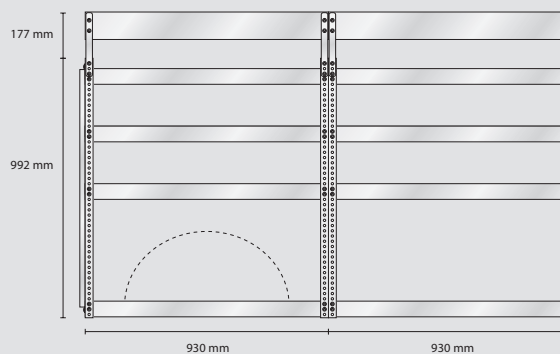

Unassembled EAN: 185677  
Assembled EAN: 184632

Unassembled EAN: 188227  
Assembled EAN: 184229

Unassembled EAN: 188234  
Assembled EAN: 184236

## MODEL SS14 – standard

Unassembled EAN: 185714

Assembled EAN: 182676

Content: 9 pcs. Shelf bin 4-800  
5 pcs. Shelf bin 5-600  
8 pcs. Shelf bin 6-1100  
9 pcs. Shelf bin 8-2000  
2 pcs. Perforated panels

Total weight: 75,9 kg

S191 weight 24,2 kg

S31 weight 25,8 kg

S32 weight 26,2 kg

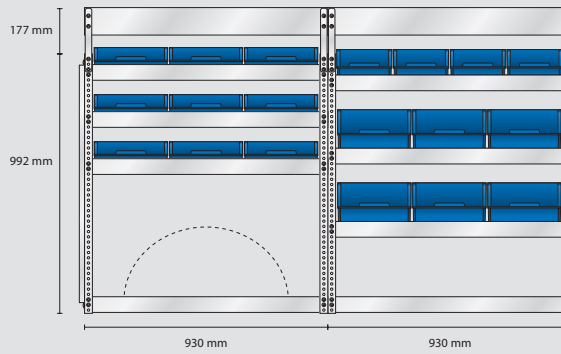

Unassembled EAN: 185684  
Assembled EAN: 184649

Unassembled EAN: 187305  
Assembled EAN: 183307

Unassembled EAN: 187312  
Assembled EAN: 183314

## MODEL ES14 – electrician

Unassembled EAN: 185721

Assembled EAN: 182683

Content: 21 pcs. Shelf bin 4-800  
4 pcs. Shelf bin 6-1100  
1 pcs. Alu drawer  
2 pcs. Perforated panels

Total weight: 78,4 kg

S191 weight 24,2 kg

S34 weight 28,7 kg

S35 weight 25,8 kg

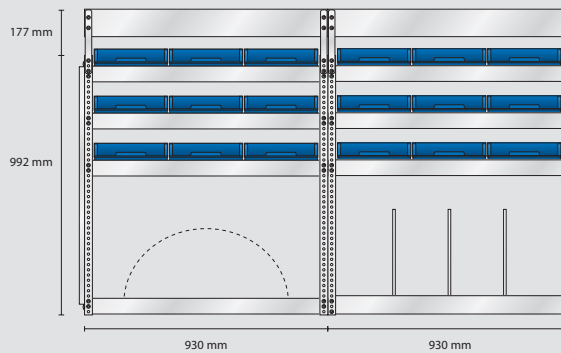

Unassembled EAN: 185684  
Assembled EAN: 184649

Unassembled EAN: 187336  
Assembled EAN: 183338

Unassembled EAN: 187343  
Assembled EAN: 183345

## MODEL VS14 – plumber

Unassembled EAN: 185738

Assembled EAN: 182690

Content: 15 pcs. Shelf bin 4-800  
5 pcs. Shelf bin 5-600  
4 pcs. Shelf bin 6-1100  
3 pcs. Shelf bin 8-2000  
2 pcs. CarryLite 80-15  
1 pcs. Alu drawer  
2 pcs. Perforated panels

Total weight: 79,6 kg

S189 weight 26,2 kg

S37 weight 28,5 kg

S38 weight 25,2 kg

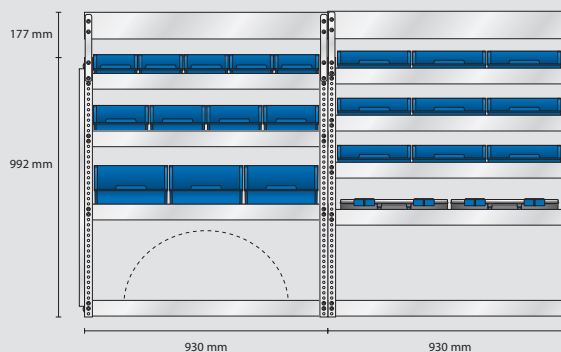

Unassembled EAN: 185660  
Assembled EAN: 184625

Unassembled EAN: 187367  
Assembled EAN: 183369

Unassembled EAN: 187374  
Assembled EAN: 183376

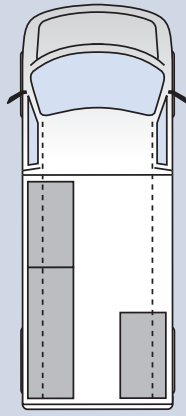

### The shelving position in the van

The depth of all modules is 380 mm.  
Adjustment of end walls may be necessary.

### Fits the following models

- Fiat Talento L1/H1
- Ford Custom L1/H1
- Mercedes Vito L2
- Renault Traffic L1/H1

### MODEL AS7 – alternative

Unassembled EAN: 186186

Assembled EAN: 182188

Content: 6 pcs. Shelf bin 4-800  
13 pcs. Shelf bin 5-600  
6 pcs. Shelf bin 8-2000  
2 pcs. CarryLite 80-15  
3 pcs. Alu drawers  
3 pcs. Perforated panels

Total weight: 86,9 kg

**S30** weight 28,9 kg

**S39** weight 30,3 kg

**S40** weight 28 kg

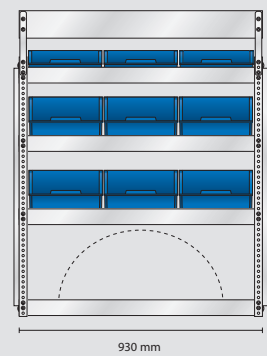
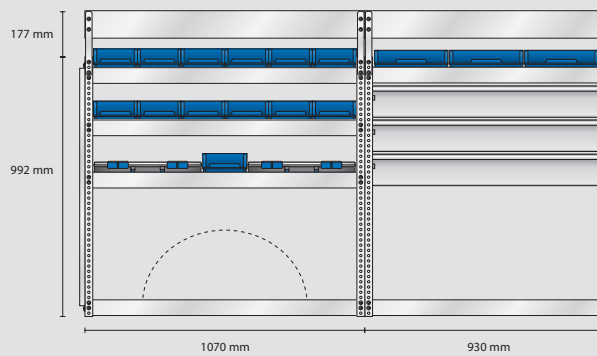

Unassembled EAN: 187299  
Assembled EAN: 183291

Unassembled EAN: 187381  
Assembled EAN: 183383

Unassembled EAN: 187398  
Assembled EAN: 183390

### MODEL AS8 – alternative

Unassembled EAN: 186193

Assembled EAN: 182195

Content: 3 pcs. Perforated panels

Total weight: 57,4 kg

**S41** weight 20,1 kg

**S126** weight 17,4 kg

**S127** weight 20,2 kg

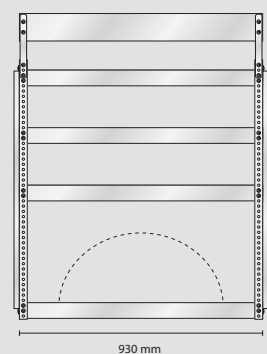
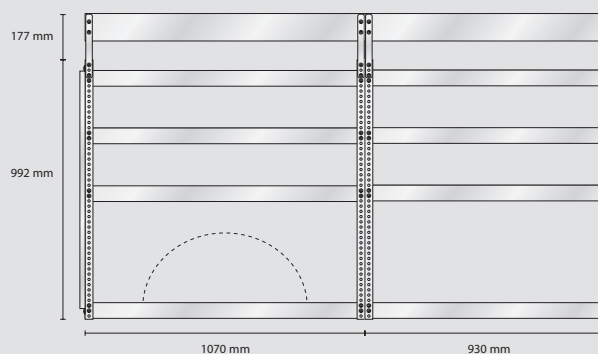

Unassembled EAN: 187404  
Assembled EAN: 183406

Unassembled EAN: 188227  
Assembled EAN: 184229

Unassembled EAN: 188234  
Assembled EAN: 184236

## MODEL SS4 – standard

Unassembled EAN: 186155

Assembled EAN: 182157

Content: 23 pcs. Shelf bin 5-600  
8 pcs. Shelf bin 6-1100  
9 pcs. Shelf bin 8-2000  
2 pcs. Perforated panels

Total weight: 79 kg

**S36** weight 27,3 kg

**S31** weight 25,8 kg

**S32** weight 26,2 kg

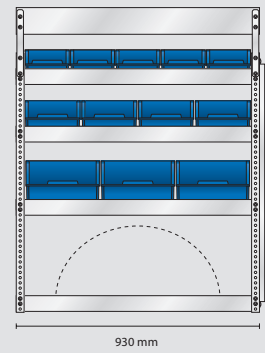
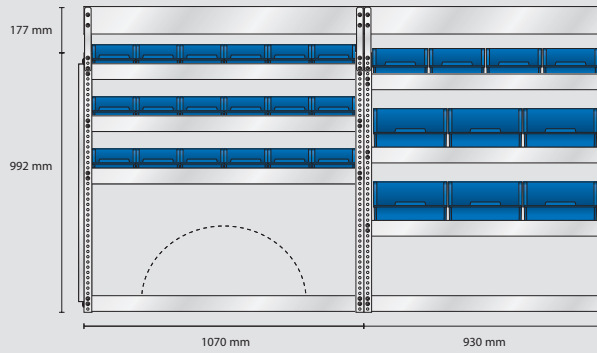

Unassembled EAN: 187350  
Assembled EAN: 183352

Unassembled EAN: 187305  
Assembled EAN: 183307

Unassembled EAN: 187312  
Assembled EAN: 183314

## MODEL ES4 – electrician

Unassembled EAN: 186162

Assembled EAN: 182164

Content: 12 pcs. Shelf bin 4-800  
8 pcs. Shelf bin 5-600  
4 pcs. Shelf bin 6-1100  
4 pcs. CarryLite 80-15  
1 pcs. Alu drawer  
2 pcs. Perforated panels

Total weight: 84,7 kg

**S33** weight 30,5 kg

**S34** weight 28,7 kg

**S35** weight 25,8 kg

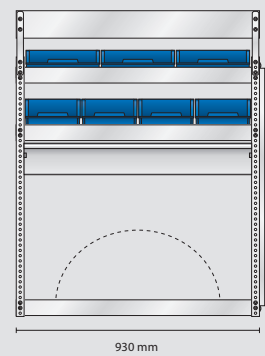
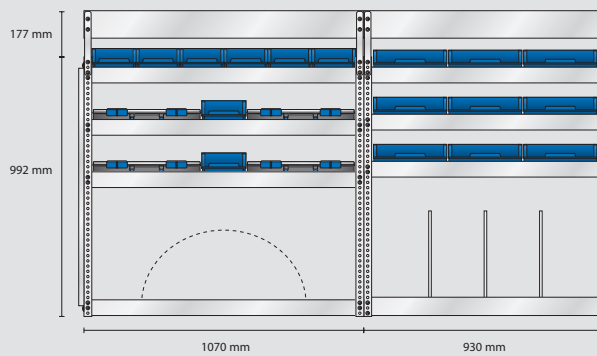

Unassembled EAN: 187329  
Assembled EAN: 183321

Unassembled EAN: 187336  
Assembled EAN: 183338

Unassembled EAN: 187343  
Assembled EAN: 183345

## MODEL VS4 – plumber

Unassembled EAN: 186179

Assembled EAN: 182171

Content: 15 pcs. Shelf bin 4-800  
18 pcs. Shelf bin 5-600  
2 pcs. CarryLite 80-15  
1 pcs. Alu drawer  
2 pcs. Perforated panels

Total weight: 80,7 kg

**S36** weight 27,3 kg

**S37** weight 28,5 kg

**S38** weight 25,2 kg

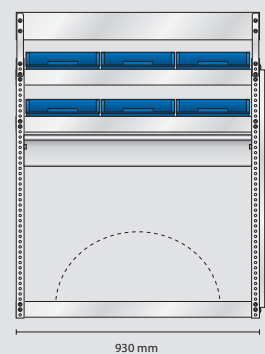
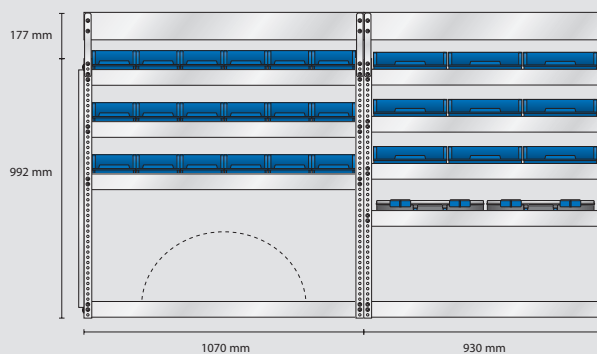

Unassembled EAN: 187350  
Assembled EAN: 183352

Unassembled EAN: 187367  
Assembled EAN: 183369

Unassembled EAN: 187374  
Assembled EAN: 183376

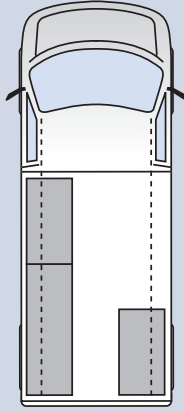

### The shelving position in the van

The depth of all modules is 380 mm.  
Adjustment of end walls may be necessary.

### Fits the following models

- Ford Custom L1/H2
- Nissan Interstar L1/H1
- Nissan Interstar L1/H2
- Renault Master L1/H1
- Renault Master L1/H2

## MODEL AS9 – alternative

Unassembled EAN: 186230

Assembled EAN: 182232

Content: 3 pcs. Shelf bin 4-800  
24 pcs. Shelf bin 5-600  
4 pcs. Shelf bin 6-1100  
9 pcs. Shelf bin 8-2000  
2 pcs. CarryLite 80-15  
4 pcs. Alu drawers  
3 pcs. Perforated panels

Total weight: 111,8 kg

**S48** weight 35,7 kg

**S52** weight 41,3 kg

**S51** weight 35,1 kg

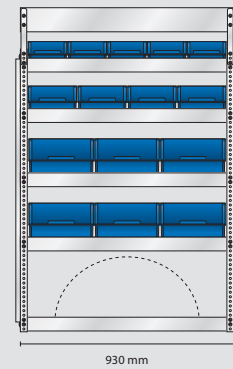
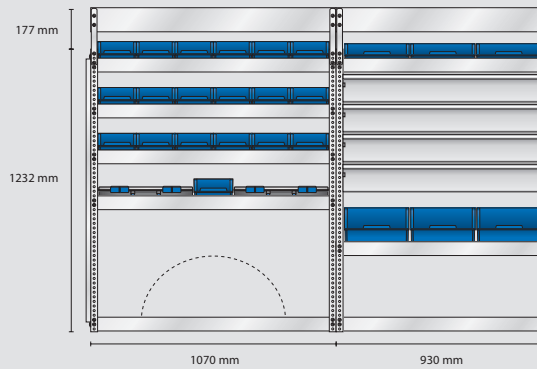

Unassembled EAN: 187473  
Assembled EAN: 183475

Unassembled EAN: 187510  
Assembled EAN: 183512

Unassembled EAN: 187503  
Assembled EAN: 183505

## MODEL AS10 – alternative

Unassembled EAN: 186247

Assembled EAN: 182249

Content: 3 pcs. Perforated panels

Total weight: 68,2 kg

**S53** weight 24,5 kg

**S54** weight 21,1 kg

**S129** weight 22,9 kg

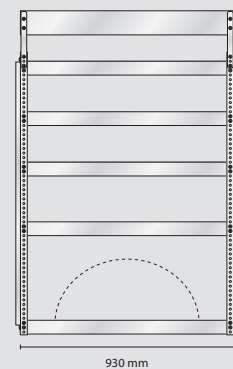
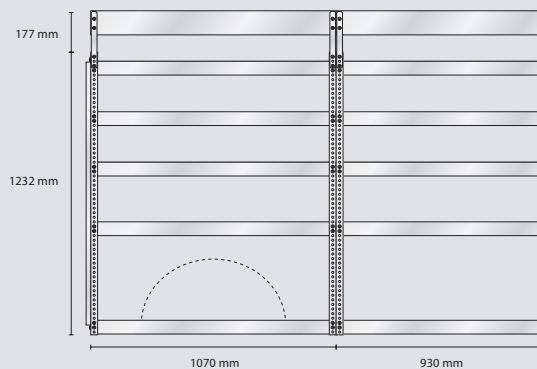

Unassembled EAN: 187527  
Assembled EAN: 183529

Unassembled EAN: 187534  
Assembled EAN: 183536

Unassembled EAN: 188258  
Assembled EAN: 184250



## MODEL SS5 – standard

Unassembled EAN: 186209

Assembled EAN: 182201

Content: 34 pcs. Shelf bin 5-600  
12 pcs. Shelf bin 6-1100  
9 pcs. Shelf bin 8-2000  
2 pcs. Perforated panels

Total weight: 98 kg

S42 weight 34,1 kg

S43 weight 31,5 kg

S44 weight 32,7 kg

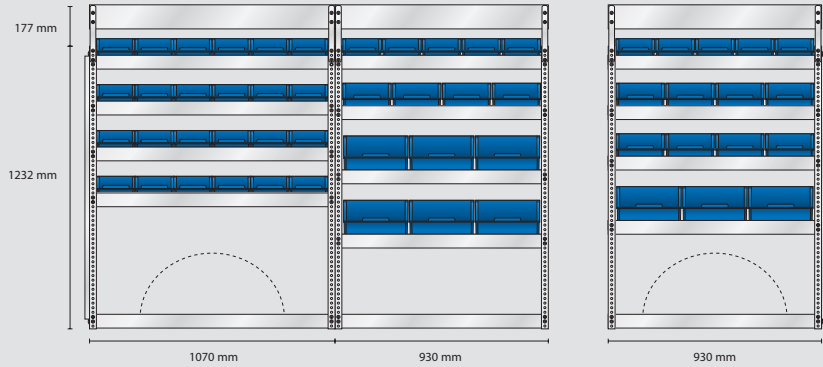

Unassembled EAN: 187411

Unassembled EAN: 187428

Unassembled EAN: 187435

Assembled EAN: 183413

Assembled EAN: 183420

Assembled EAN: 183437

## MODEL ES5 – electrician

Unassembled EAN: 186216

Assembled EAN: 182218

Content: 18 pcs. Shelf bin 4-800  
14 pcs. Shelf bin 5-600  
4 pcs. Shelf bin 6-1100  
4 pcs. CarryLite 80-15  
1 pcs. Alu drawer  
2 pcs. Perforated panels

Total weight: 102,9 kg

S45 weight 37,3 kg

S46 weight 34,2 kg

S47 weight 31,7 kg

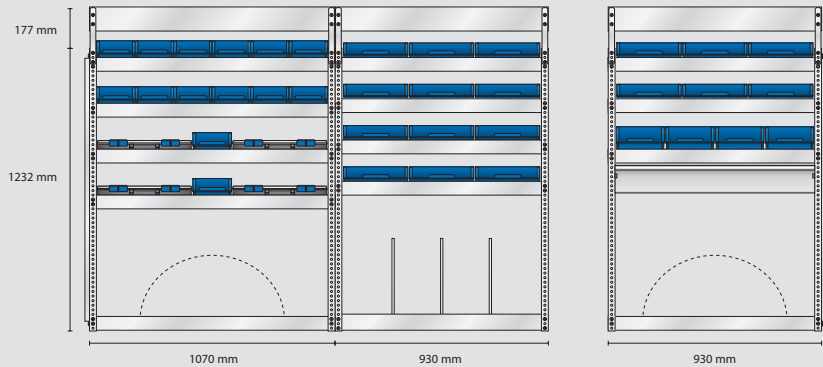

Unassembled EAN: 187442

Unassembled EAN: 187459

Unassembled EAN: 187466

Assembled EAN: 183444

Assembled EAN: 183451

Assembled EAN: 183468

## MODEL VS5 – plumber

Unassembled EAN: 186223

Assembled EAN: 182225

Content: 21 pcs. Shelf bin 4-800  
19 pcs. Shelf bin 5-600  
2 pcs. CarryLite 80-15  
2 pcs. Alu drawers  
2 pcs. Perforated panels

Total weight: 99,7 kg

S48 weight 35,7 kg

S49 weight 33,2 kg

S50 weight 31,1 kg

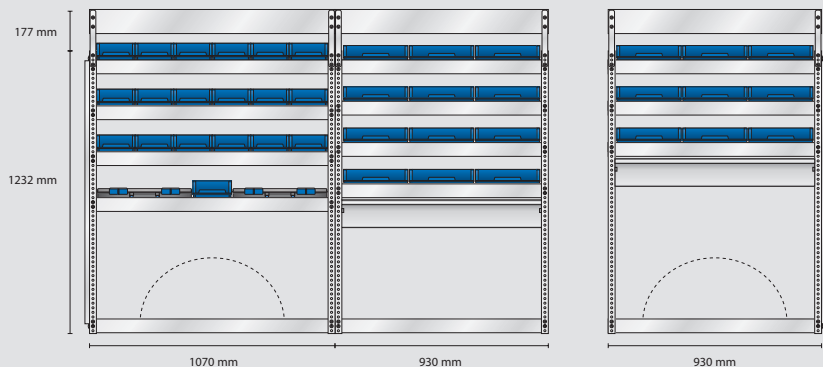

Unassembled EAN: 187473

Unassembled EAN: 187480

Unassembled EAN: 187497

Assembled EAN: 183475

Assembled EAN: 183482

Assembled EAN: 183499

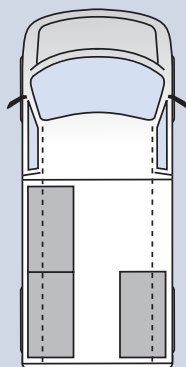

### The shelving position in the van

The depth of all modules is 380 mm.  
Adjustment of end walls may be necessary.

### Fits the following models

- Citroën Jumpy L3 (XL)
- Opel Vivaro L3
- Fiat Talento L2/H1
- Peugeot Expert L3 (XL)
- Nissan Primastar L2
- Renault Traffic L2/H1
- Toyota Proace L3

### MODEL AS11 – alternative

Unassembled EAN: 186285

Assembled EAN: 182287

Content: 11 pcs. Shelf bin 4-800  
18 pcs. Shelf bin 5-600  
4 pcs. Shelf bin 8-2000  
3 pcs. Alu drawers  
3 pcs. Perforated panels

Total weight: 90,8 kg

**S58** weight 28,9 kg

**S39** weight 30,3 kg

**S130** weight 31,9 kg

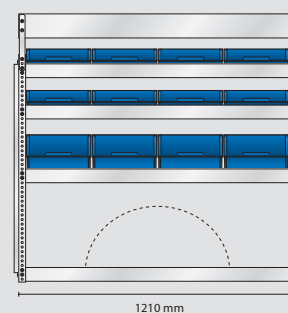
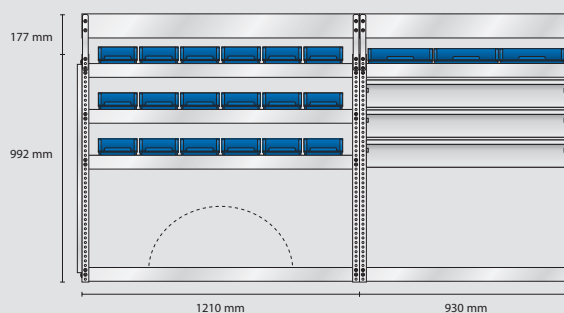

Unassembled EAN: 187572  
Assembled EAN: 183574

Unassembled EAN: 187381  
Assembled EAN: 183383

Unassembled EAN: 188265  
Assembled EAN: 184267

### MODEL AS12– alternative

Unassembled EAN: 186292

Assembled EAN: 182294

Content: 3 pcs. Perforated panels

Total weight: 61,9 kg

**S59** weight 21,7 kg

**S126** weight 17,4 kg

**S131** weight 23,1 kg

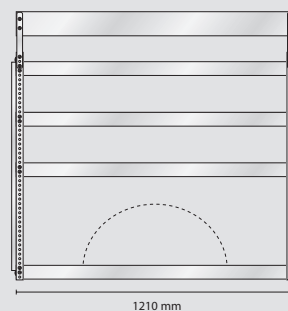
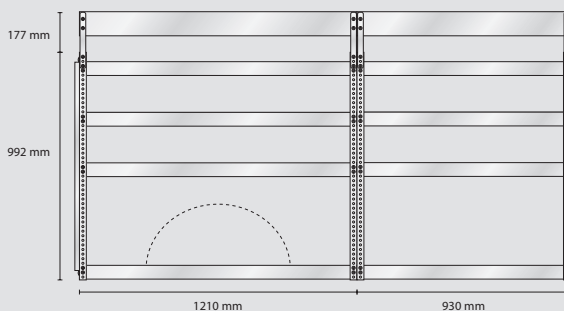

Unassembled EAN: 187589  
Assembled EAN: 183581

Unassembled EAN: 188227  
Assembled EAN: 184229

Unassembled EAN: 188272  
Assembled EAN: 184274

## MODEL SS6 – standard

Unassembled EAN: 186254

Assembled EAN: 182256

Content: 16 pcs. Shelf bin 4-800  
4 pcs. Shelf bin 6-1100  
14 pcs. Shelf bin 8-2000  
2 pcs. Perforated panels

Total weight: 86,5 kg

**S128** weight 30,5 kg

**S31** weight 25,8 kg

**S79** weight 30,5 kg

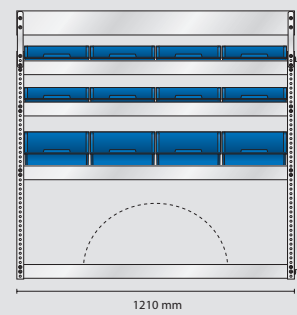
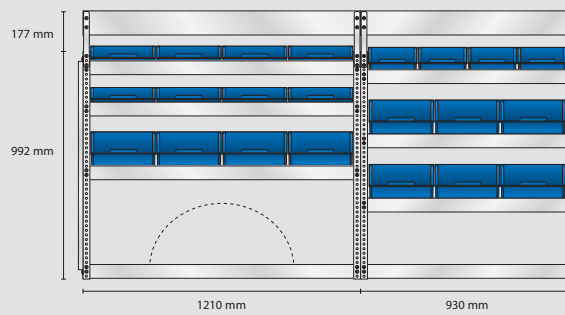

Unassembled EAN: 188241

Assembled EAN: 184243

Unassembled EAN: 187305

Assembled EAN: 183307

Unassembled EAN: 187787

Assembled EAN: 183789

## MODEL ES6 – electrician

Unassembled EAN: 186261

Assembled EAN: 182263

Content: 15 pcs. Shelf bin 4-800  
6 pcs. Shelf bin 5-600  
5 pcs. Shelf bin 6-1100  
4 pcs. Shelf bin 8-2000  
4 pcs. CarryLite 80-15  
2 pcs. Perforated panels

Total weight: 91,4 kg

**S56** weight 32,5 kg

**S34** weight 28,7 kg

**S80** weight 31,1 kg

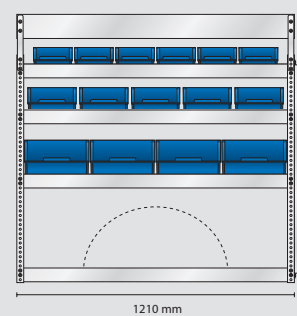
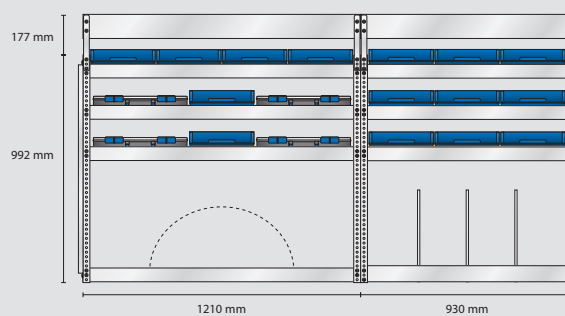

Unassembled EAN: 187558

Assembled EAN: 183550

Unassembled EAN: 187336

Assembled EAN: 183338

Unassembled EAN: 187794

Assembled EAN: 183796

## MODEL VS6 – plumber

Unassembled EAN: 186278

Assembled EAN: 182270

Content: 29 pcs. Shelf bin 4-800  
2 pcs. CarryLite 80-15  
1 pcs. Alu drawer  
2 pcs. Perforated panels

Total weight: 86,2 kg

**S57** weight 28,9 kg

**S37** weight 28,5 kg

**S81** weight 29,1 kg

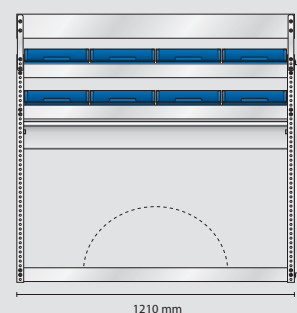
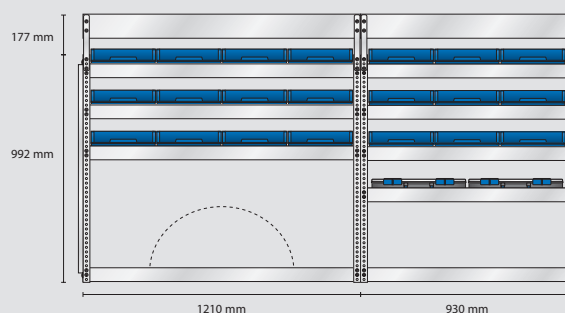

Unassembled EAN: 187565

Assembled EAN: 183567

Unassembled EAN: 187367

Assembled EAN: 183369

Unassembled EAN: 187800

Assembled EAN: 183802

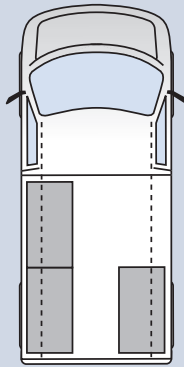

### The shelving position in the van

The depth of all modules is 380 mm.  
Adjustment of end walls may be necessary.

### Fits the following models

- Citroën Jumper L1/H1
- Fiat Ducato L1/H1
- Ford Custom L2/H2
- Mercedes Sprinter L1/H1
- Opel Movano L1/H1
- Peugeot Boxer L1/H1

## MODEL AS13 – alternative

Unassembled EAN: 186339

Assembled EAN: 182331

Content: 3 pcs. Shelf bin 4-800  
30 pcs. Shelf bin 5-600  
10 pcs. Shelf bin 6-1100  
7 pcs. Shelf bin 8-2000  
4 pcs. Alu drawers  
3 pcs. Perforated panels

Total weight: 117,8 kg

**S63** weight 36,1 kg

**S52** weight 41,3 kg

**S134** weight 40,7 kg

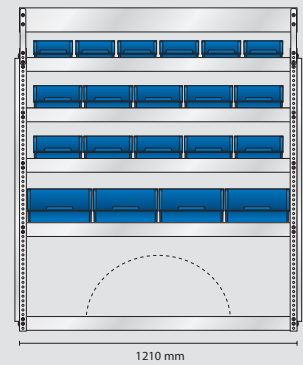
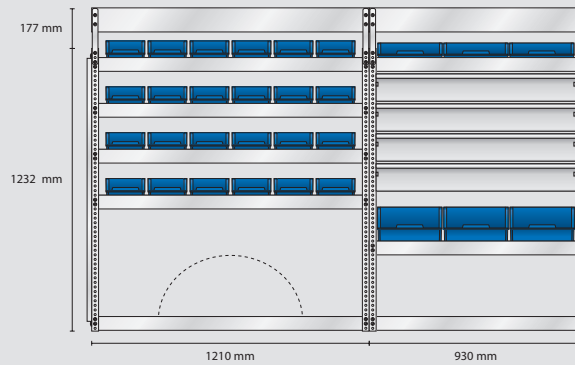

Unassembled EAN: 187626

Assembled EAN: 183628

Unassembled EAN: 187510

Assembled EAN: 183512

Unassembled EAN: 188302

Assembled EAN: 184304

## MODEL AS14 – alternative

Unassembled EAN: 186346

Assembled EAN: 182348

Content: 3 pcs. Perforated panels

Total weight: 75,6 kg

**S64** weight 26,5 kg

**S54** weight 21,1 kg

**S122** weight 28,3 kg

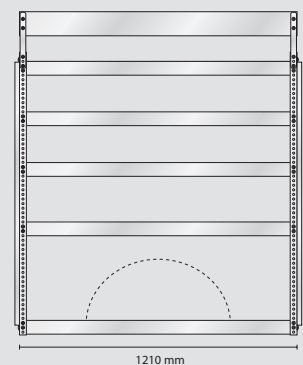
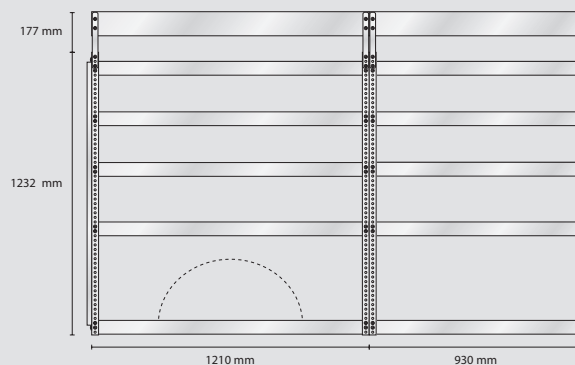

Unassembled EAN: 187633

Assembled EAN: 183635

Unassembled EAN: 187534

Assembled EAN: 183536

Unassembled EAN: 188180

Assembled EAN: 184182

## MODEL SS7 – standard

Unassembled EAN: 186308

Assembled EAN: 182300

Content: 8 pcs. Shelf bin 4-800  
 11 pcs. Shelf bin 5-600  
 14 pcs. Shelf bin 6-1100  
 18 pcs. Shelf bin 8-2000  
 2 pcs. Perforated panels

Total weight: 109,4 kg

**S60** weight 39,3 kg

**S43** weight 31,5 kg

**S84** weight 38,9 kg

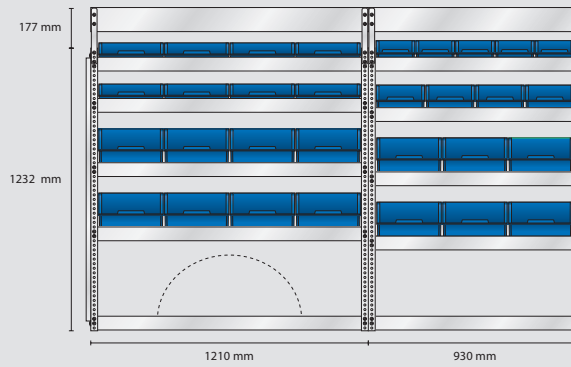

Unassembled EAN: 187596  
 Assembled EAN: 183598

Unassembled EAN: 187428  
 Assembled EAN: 183420

Unassembled EAN: 187831  
 Assembled EAN: 183833

## MODEL ES7 – electrician

Unassembled EAN: 186315

Assembled EAN: 182317

Content: 22 pcs. Shelf bin 4-800  
 12 pcs. Shelf bin 5-600  
 5 pcs. Shelf bin 6-1100  
 4 pcs. CarryLite 80-15  
 1 pcs. Alu drawer  
 2 pcs. Perforated panels

Total weight: 110,5 kg

**S61** weight 39,7 kg

**S46** weight 34,2 kg

**S85** weight 36,9 kg

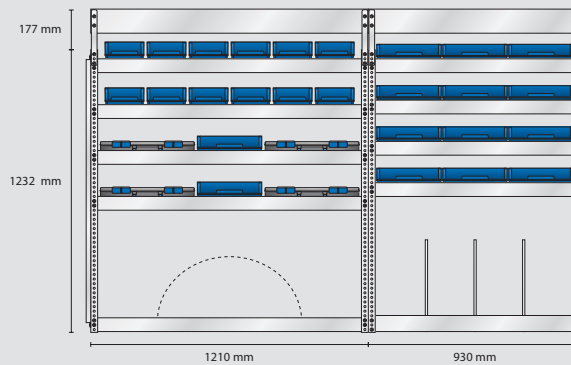

Unassembled EAN: 187602  
 Assembled EAN: 183604

Unassembled EAN: 187459  
 Assembled EAN: 183451

Unassembled EAN: 187848  
 Assembled EAN: 183840

## MODEL VS7 – plumber

Unassembled EAN: 186322

Assembled EAN: 182324

Content: 46 pcs. Shelf bin 4-800  
 4 pcs. CarryLite 80-15  
 1 pcs. Alu drawer  
 2 pcs. Perforated panels

Total weight: 119,1 kg

**S62** weight 41,3 kg

**S132** weight 36,8 kg

**S133** weight 41,3 kg

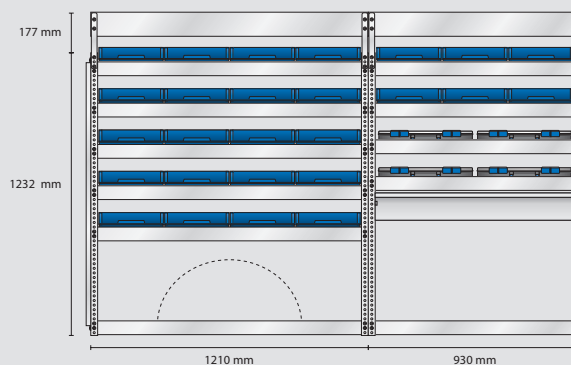

Unassembled EAN: 187619  
 Assembled EAN: 183611

Unassembled EAN: 188289  
 Assembled EAN: 184281

Unassembled EAN: 188296  
 Assembled EAN: 184298

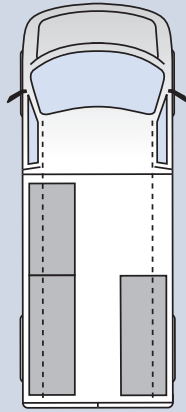

### The shelving position in the van

The depth of all modules is 380 mm.  
Adjustment of end walls may be necessary.

### Fits the following model

- Mercedes Sprinter L1/H2

### MODEL AS15 – alternative

Unassembled EAN: 186384

Assembled EAN: 182386

- Content:
- 3 pcs. Shelf bin 4-800
  - 42 pcs. Shelf bin 5-600
  - 5 pcs. Shelf bin 6-1100
  - 11 pcs. Shelf bin 8-2000
  - 4 pcs. Alu drawers
  - 3 pcs. Perforated panels

Total weight: 133,4 kg

**S65** weight 42,7 kg

**S75** weight 42,7 kg

**S76** weight 48,3 kg

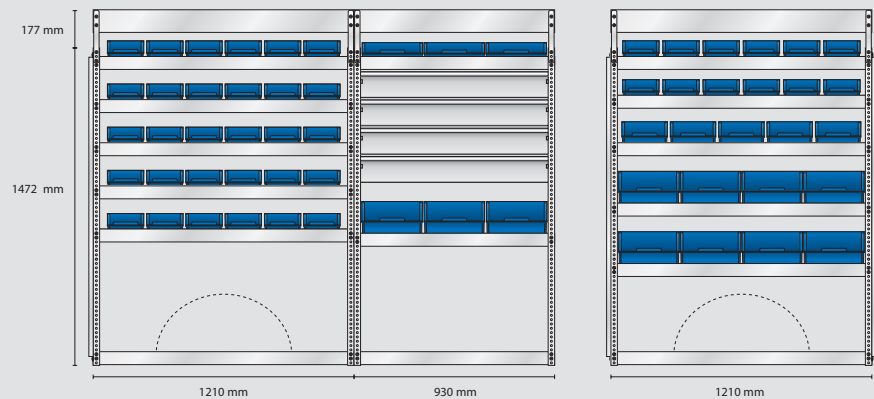

Unassembled EAN: 187640

Assembled EAN: 183642

Unassembled EAN: 187749

Assembled EAN: 183741

Unassembled EAN: 187756

Assembled EAN: 183758

### MODEL AS16 – alternative

Unassembled EAN: 186391

Assembled EAN: 182393

- Content:
- 3 pcs. Perforated panels

Total weight: 87,5 kg

**S77** weight 30,7 kg

**S78** weight 24,6 kg

**S123** weight 32,5 kg

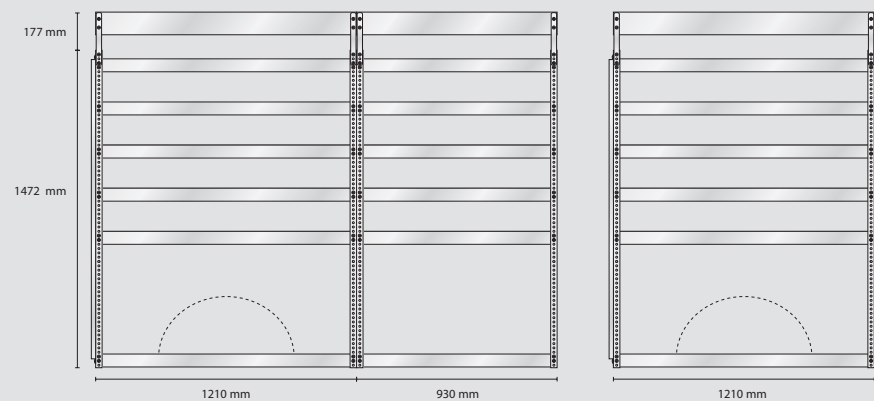

Unassembled EAN: 187763

Assembled EAN: 183765

Unassembled EAN: 187770

Assembled EAN: 183772

Unassembled EAN: 188197

Assembled EAN: 184199

## MODEL SS8 – standard

Unassembled EAN: 186353

Assembled EAN: 182355

Content: 36 pcs. Shelf bin 5-600  
22 pcs. Shelf bin 6-1100  
14 pcs. Shelf bin 8-2000  
2 pcs. Perforated panels

Total weight: 127,3 kg

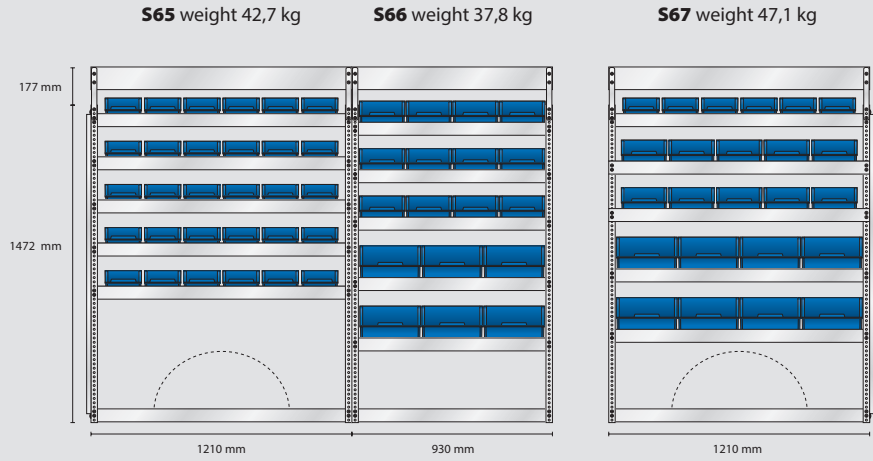

Unassembled EAN: 187640  
Assembled EAN: 183642

Unassembled EAN: 187657  
Assembled EAN: 183659

Unassembled EAN: 187664  
Assembled EAN: 183666

## MODEL ES8 – electrician

Unassembled EAN: 186360

Assembled EAN: 182362

Content: 25 pcs. Shelf bin 4-800  
18 pcs. Shelf bin 5-600  
10 pcs. Shelf bin 6-1100  
4 pcs. CarryLite 80-15  
1 pcs. Alu drawer  
2 pcs. Perforated panels

Total weight: 129,6 kg

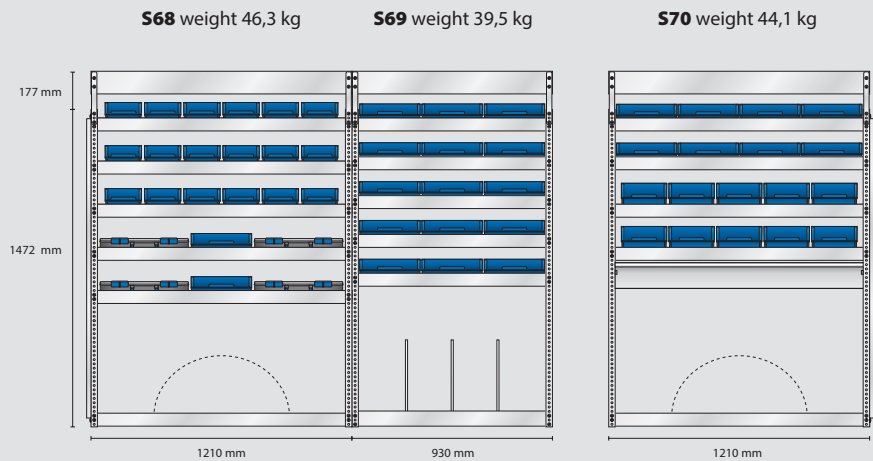

Unassembled EAN: 187671  
Assembled EAN: 183673

Unassembled EAN: 187688  
Assembled EAN: 183680

Unassembled EAN: 187695  
Assembled EAN: 183697

## MODEL VS8 – plumber

Unassembled EAN: 186377

Assembled EAN: 182379

Content: 49 pcs. Shelf bin 4-800  
4 pcs. CarryLite 80-15  
1 pcs. Alu drawer  
2 pcs. Perforated panels

Total weight: 127,2 kg

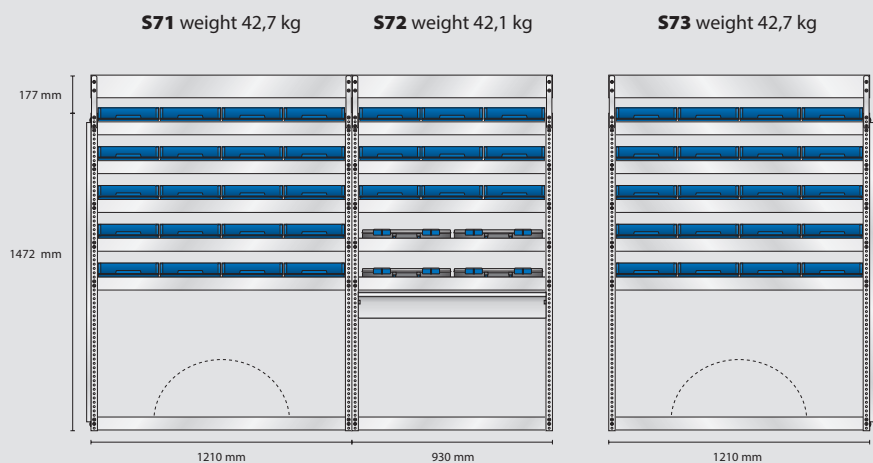

Unassembled EAN: 187701  
Assembled EAN: 183703

Unassembled EAN: 187718  
Assembled EAN: 183710

Unassembled EAN: 187725  
Assembled EAN: 183727

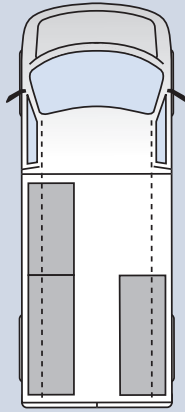

### The shelving position in the van

The depth of all modules is 380 mm.  
Adjustment of end walls may be necessary.

### Fits the following model

- Ford Custom L2/H1
- Mercedes Vito L3
- Transporter L2/H1
- Transporter L2/H2

### MODEL AS17 – alternative

Unassembled EAN: 186438  
Assembled EAN: 182430

Content: 12 pcs. 4-800  
15 pcs. 6-1100  
8 pcs. 8-2000  
3 pcs. Bins  
3 pcs. Perforated panels

Total weight: 103 kg

**S137** weight 30,7 kg

**S83** weight 40,1 kg

**S130** weight 31,9 kg

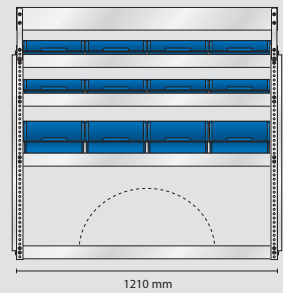
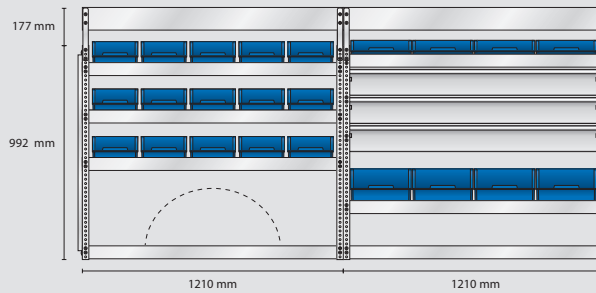

Unassembled EAN: 188333  
Assembled EAN: 184335

Unassembled EAN: 187824  
Assembled EAN: 183826

Unassembled EAN: 188265  
Assembled EAN: 184267

### MODEL AS18 – alternative

Unassembled EAN: 186445  
Assembled EAN: 182447

Content: 3 pcs. Perforated panels

Total weight: 64,8 kg

**S59** weight 21,7 kg

**S138** weight 20,3 kg

**S131** weight 23,1 kg

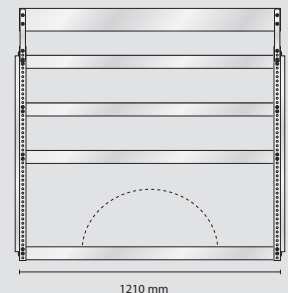
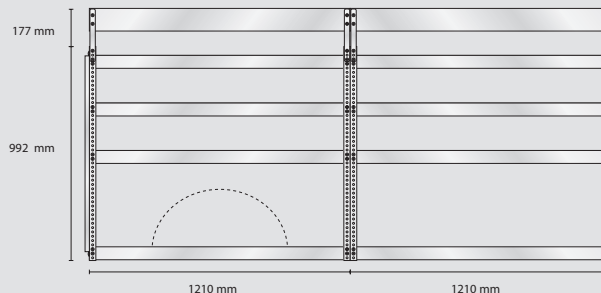

Unassembled EAN: 187589  
Assembled EAN: 183581

Unassembled EAN: 188340  
Assembled EAN: 184342

Unassembled EAN: 188272  
Assembled EAN: 184274



## MODEL SS9 – standard

Unassembled EAN: 186407

Assembled EAN: 182409

Content: 12 pcs. 5-600  
25 pcs. 6-1100  
8 pcs. 8-2000  
2 pcs. Perforated panels

Total weight: 91,2 kg

**S135** weight 31,1 kg

**S136** weight 29,3 kg

**S80** weight 31,1 kg

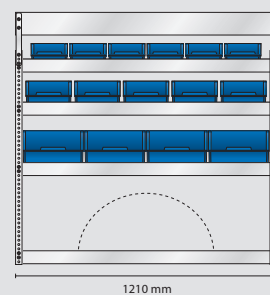
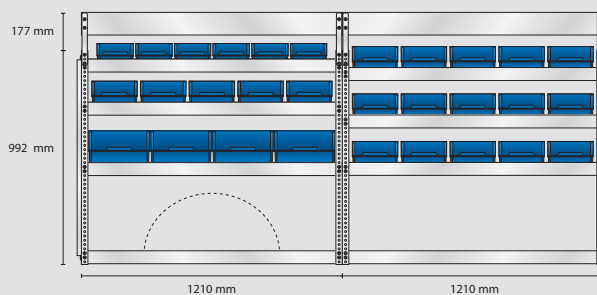

Unassembled EAN: 188319  
Assembled EAN: 184311

Unassembled EAN: 188326  
Assembled EAN: 184328

Unassembled EAN: 187794  
Assembled EAN: 183796

## MODEL ES9 – electrician

Unassembled EAN: 186414

Assembled EAN: 182416

Content: 26 pcs. 4-800  
4 pcs. CarryLite 80-15  
1 pcs. Bin  
2 pcs. Perforated panels

Total weight: 95,3 kg

**S56** weight 32,5 kg

**S120** weight 34 kg

**S81** weight 29,1 kg

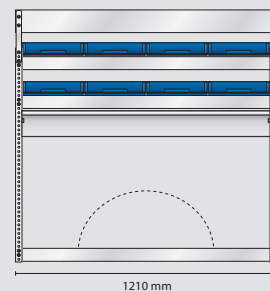
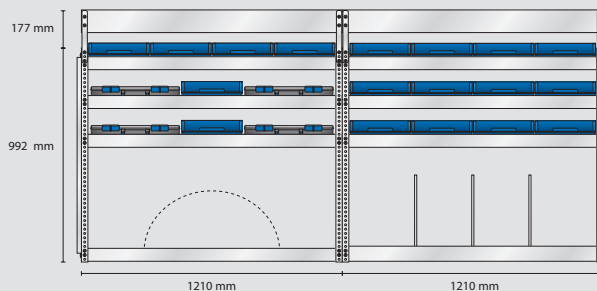

Unassembled EAN: 187558  
Assembled EAN: 183550

Unassembled EAN: 188166  
Assembled EAN: 184168

Unassembled EAN: 187800  
Assembled EAN: 183802

## MODEL VS9 – Plumber

Unassembled EAN: 186421

Assembled EAN: 182423

Content: 32 pcs. 4-800  
4 pcs. 8-2000  
1 pcs. Bin  
2 pcs. Perforated panels

Total weight: 92 kg

**S57** weight 28,9 kg

**S82** weight 32,9 kg

**S79** weight 30,5 kg

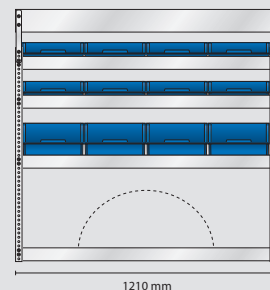
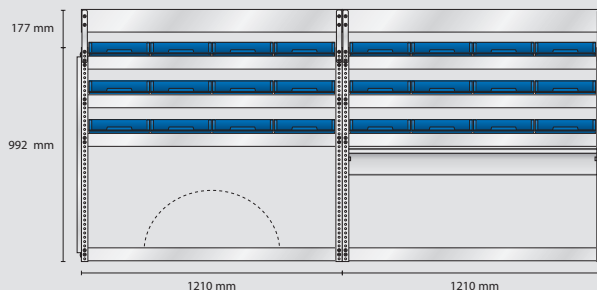

Unassembled EAN: 187565  
Assembled EAN: 183567

Unassembled EAN: 187817  
Assembled EAN: 183819

Unassembled EAN: 187787  
Assembled EAN: 183789

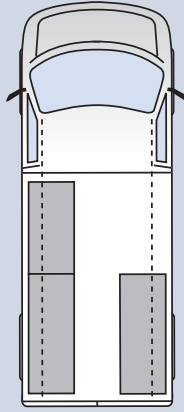

### The shelving position in the van

The depth of all modules is 380 mm.  
Adjustment of end walls may be necessary.

### Fits the following models

- Fiat Ducato L2/H1
- Peugeot Boxer L2/H1
- Iveco Daily 9m3 L2/H1
- Volkswagen Crafter L3/H2
- Opel Movano L2/H1

### MODEL AS19 – alternative

Unassembled EAN: 186483

Assembled EAN: 182485

Content: 12 pcs. Shelf bin 4-800  
24 pcs. Shelf bin 5-600  
12 pcs. Shelf bin 8-2000  
4 pcs. Alu drawers  
3 pcs. Perforated panels

Total weight: 124 kg

**S63** weight 36,1 kg

**S121** weight 47,1 kg

**S140** weight 41,4 kg

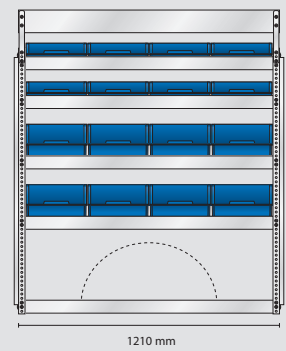
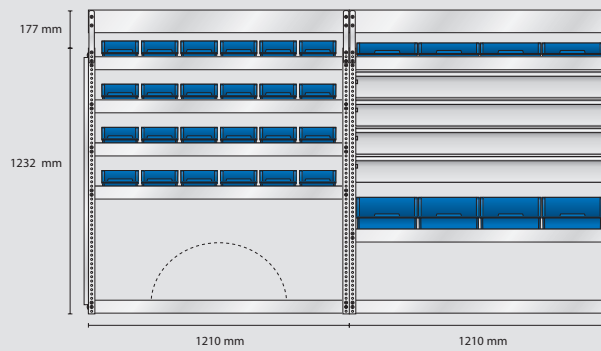

Unassembled EAN: 187626  
Assembled EAN: 183628

Unassembled EAN: 188173  
Assembled EAN: 184175

Unassembled EAN: 188364  
Assembled EAN: 184366

### MODEL AS20 – alternative

Unassembled EAN: 186490

Assembled EAN: 182492

Content: 3 pcs. Perforated panels

Total weight: 79,2 kg

**S64** weight 26,5 kg

**S141** weight 24,7 kg

**S122** weight 28,3 kg

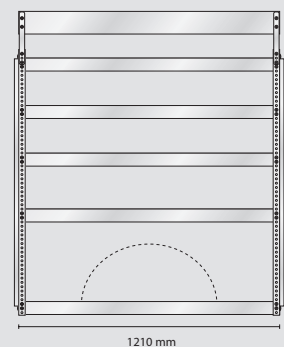
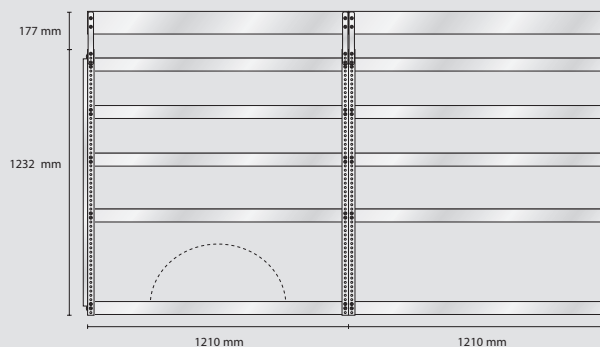

Unassembled EAN: 187633  
Assembled EAN: 183635

Unassembled EAN: 188371  
Assembled EAN: 184373

Unassembled EAN: 188180  
Assembled EAN: 184182

## MODEL SS10 – standard

Unassembled EAN: 186452  
Assembled EAN: 182454

Content: 8 pcs. Shelf bin 4-800  
12 pcs. Shelf bin 5-600  
20 pcs. Shelf bin 6-1100  
16 pcs. Shelf bin 8-2000  
2 pcs. Perforated panels

Total weight: 115 kg

**S60** weight 39,3 kg

**S125** weight 37,1 kg

**S84** weight 38,9 kg

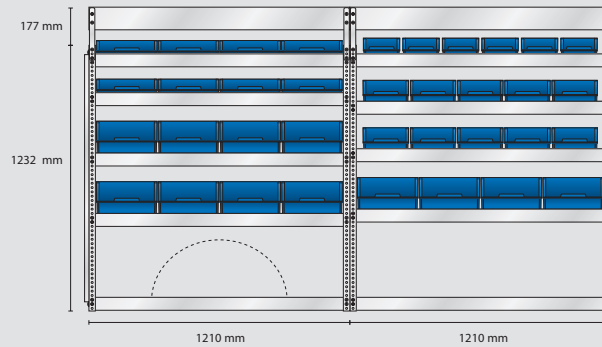

Unassembled EAN: 187596  
Assembled EAN: 183598

Unassembled EAN: 188210  
Assembled EAN: 184212

Unassembled EAN: 187831  
Assembled EAN: 183833

## MODEL ES10 – electrician

Unassembled EAN: 186469  
Assembled EAN: 182461

Content: 18 pcs. Shelf bin 4-800  
12 pcs. Shelf bin 5-600  
5 pcs. Shelf bin 6-1100  
4 pcs. Shelf bin 8-2000  
4 pcs. CarryLite 80-15  
1 pcs. Alu drawer  
2 pcs. Perforated panels

Total weight: 113,5 kg

**S61** weight 39,7 kg

**S86** weight 37,2 kg

**S85** weight 36,9 kg

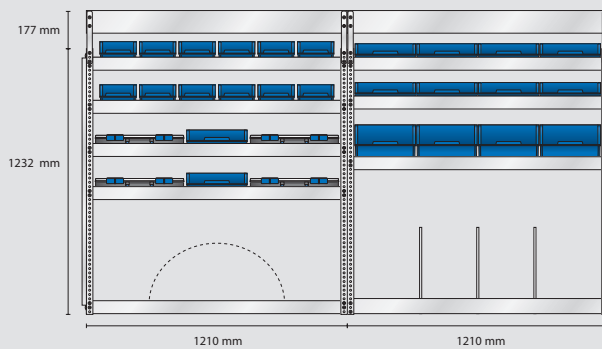

Unassembled EAN: 187602  
Assembled EAN: 183604

Unassembled EAN: 187855  
Assembled EAN: 183857

Unassembled EAN: 187848  
Assembled EAN: 183840

## MODEL VS10 – plumber

Unassembled EAN: 186476  
Assembled EAN: 182478

Content: 38 pcs. Shelf bin 4-800  
5 pcs. Shelf bin 6-1100  
4 pcs. CarryLite 80-15  
1 pcs. Alu drawer  
2 pcs. Perforated panels

Total weight: 115,8 kg

**S62** weight 41,3 kg

**S139** weight 37,9 kg

**S85** weight 36,9 kg

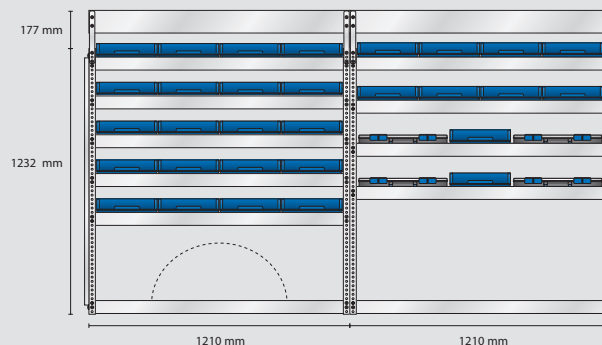

Unassembled EAN: 187619  
Assembled EAN: 183611

Unassembled EAN: 188357  
Assembled EAN: 184359

Unassembled EAN: 187848  
Assembled EAN: 183840

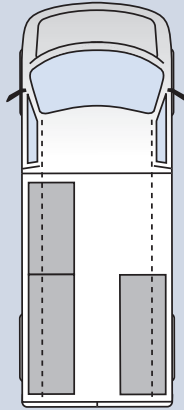

### The shelving position in the van

The depth of all modules is 380 mm.  
Adjustment of end walls may be necessary.

### Fits the following models

- Citroen Jumper L2/H2
- Fiat Ducato L2/H2
- Ford Transit 2T L2/H2
- Ford Transit 2T L2/H3
- Nissan Interstar L2/H2
- Opel Movano L2/H2
- Peugeot Boxer L2/H2
- Renault Master L2/H2
- Renault Master L2/H3

### MODEL AS21 – alternative

Unassembled EAN: 186537  
Assembled EAN: 182539

Content: 8 pcs. Shelf bin 4-800  
42 pcs. Shelf bin 5-600  
5 pcs. Shelf bin 6-1100  
12 pcs. Shelf bin 8-2000  
3 pcs. Alu drawers  
3 pcs. Perforated panels

Total weight: 137 kg

**S74** weight 40,7 kg

**S90** weight 48,3 kg

**S76** weight 48,3 kg

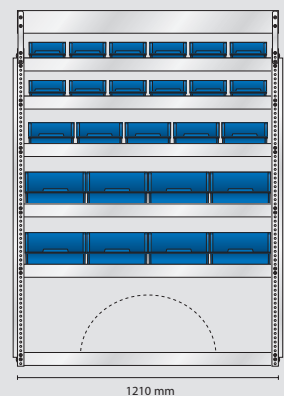
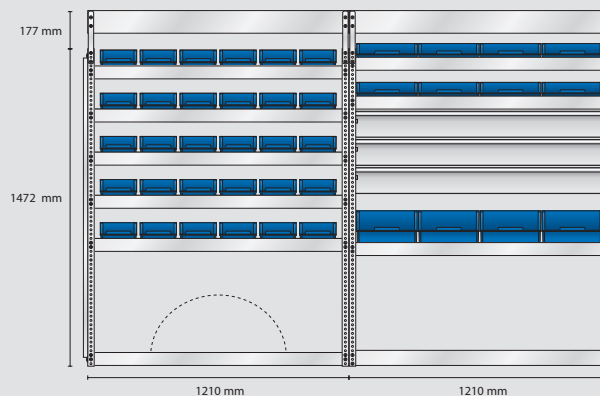

Unassembled EAN: 187732  
Assembled EAN: 183734

Unassembled EAN: 187893  
Assembled EAN: 183895

Unassembled EAN: 187756  
Assembled EAN: 183758

### MODEL AS22 – alternative

Unassembled EAN: 186544  
Assembled EAN: 182546

Content: 3 pcs. Perforated panels

Total weight: 91,8 kg

**S77** weight 30,7 kg

**S146** weight 28,9 kg

**S123** weight 32,5 kg

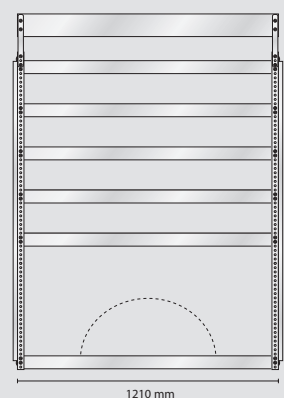
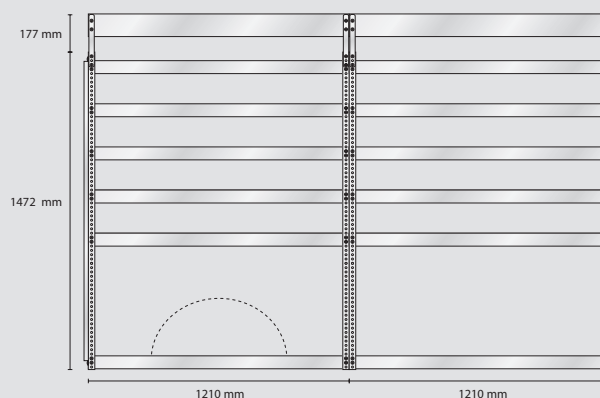

Unassembled EAN: 187763  
Assembled EAN: 183765

Unassembled EAN: 188425  
Assembled EAN: 184427

Unassembled EAN: 188197  
Assembled EAN: 184199

## MODEL SS11 – standard

Unassembled EAN: 186506

Assembled EAN: 182508

Content: 18 pcs. Shelf bin 5-600  
30 pcs. Shelf bin 6-1100  
24 pcs. Shelf bin 8-2000  
2 pcs. Perforated panels

Total weight: 139,2 kg

**S142** weight 47,1 kg

**S87** weight 45,3 kg

**S67** weight 47,1 kg

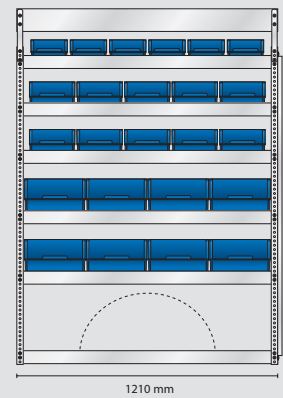
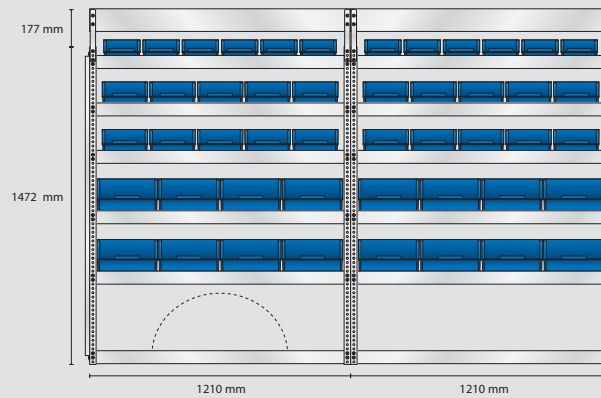

Unassembled EAN: 188388  
Assembled EAN: 184380

Unassembled EAN: 187862  
Assembled EAN: 183864

Unassembled EAN: 187664  
Assembled EAN: 183666

## MODEL ES11 – electrician

Unassembled EAN: 186513

Assembled EAN: 182515

Content: 30 pcs. Shelf bin 4-800  
18 pcs. Shelf bin 5-600  
10 pcs. Shelf bin 6-1100  
4 pcs. CarryLite 80-15  
1 pcs. Alu drawer  
2 pcs. Perforated panels

Total weight: 137,5 kg

**S68** weight 46,3 kg

**S88** weight 47,4 kg

**S70** weight 44,1 kg

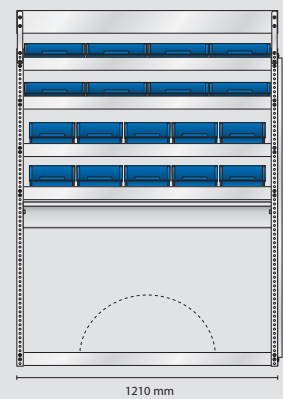
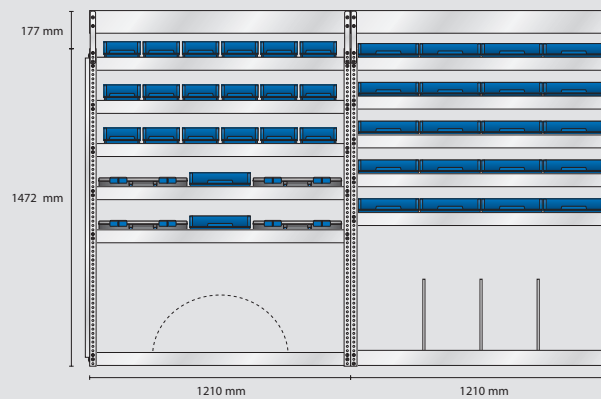

Unassembled EAN: 187671  
Assembled EAN: 183673

Unassembled EAN: 187879  
Assembled EAN: 183871

Unassembled EAN: 187695  
Assembled EAN: 183697

## MODEL VS11 – plumber

Unassembled EAN: 186520

Assembled EAN: 182522

Content: 46 pcs. Shelf bin 4-800  
8 pcs. Shelf bin 8-2000  
4 pcs. CarryLite 80-15  
1 pcs. Alu drawer  
2 pcs. Perforated panels

Total weight: 138,2 kg

**S71** weight 42,7 kg

**S89** weight 49,9 kg

**S143** weight 45,9 kg

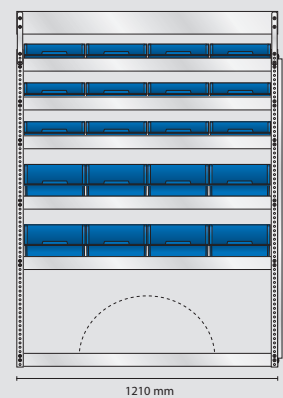
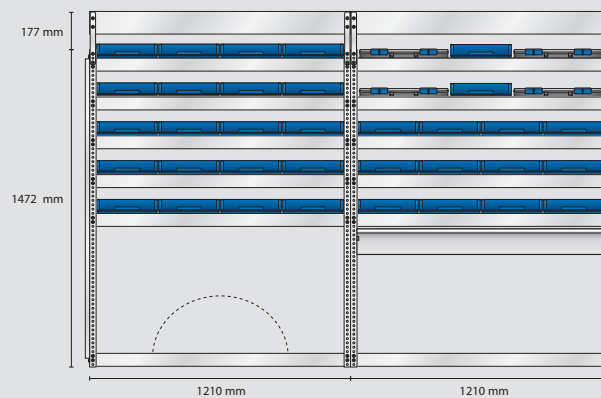

Unassembled EAN: 187701  
Assembled EAN: 183703

Unassembled EAN: 187886  
Assembled EAN: 183888

Unassembled EAN: 188395  
Assembled EAN: 184397

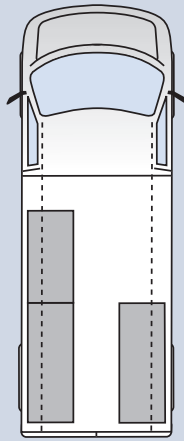

### The shelving position in the van

The depth of all modules is 380 mm.  
Adjustment of end walls may be necessary.

### Fits the following models

- Ford Transit 2T L3/H2
- Ford Transit 2T L3/H3
- Iveco Daily 10,8m3 L2/H2
- MAN TGE L3/H3
- Volkswagen Crafter L3/H3

## MODEL AS29 – alternative

Unassembled EAN: 189132  
Assembled EAN: 189149

Content: 24 pcs. Shelf bin 4-800  
40 pcs. Shelf bin 5-600  
12 pcs. Shelf bin 6-1100  
5 pcs. Shelf bin 8-2000  
4 pcs. CarryLite 80-15  
1 pcs. Alu drawer  
2 pcs. Perforated panels

Total weight: 153,8 kg

**S104** weight 51 kg

**S89** weight 49,9 kg

**S109** weight 53,2 kg

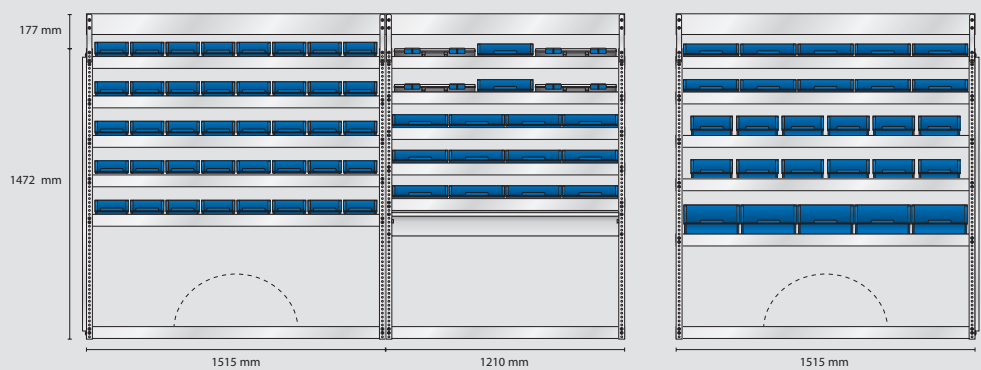

Unassembled EAN: 188012  
Assembled EAN: 184014

Unassembled EAN: 187886  
Assembled EAN: 183888

Unassembled EAN: 188067  
Assembled EAN: 184069

## MODEL AS30 – alternative

Unassembled EAN: 189156  
Assembled EAN: 189163

Content: 3 pcs. Perforated panels

Total weight: 100,4 kg

**S116** weight 35 kg

**S146** weight 28,9 kg

**S118** weight 36,8 kg

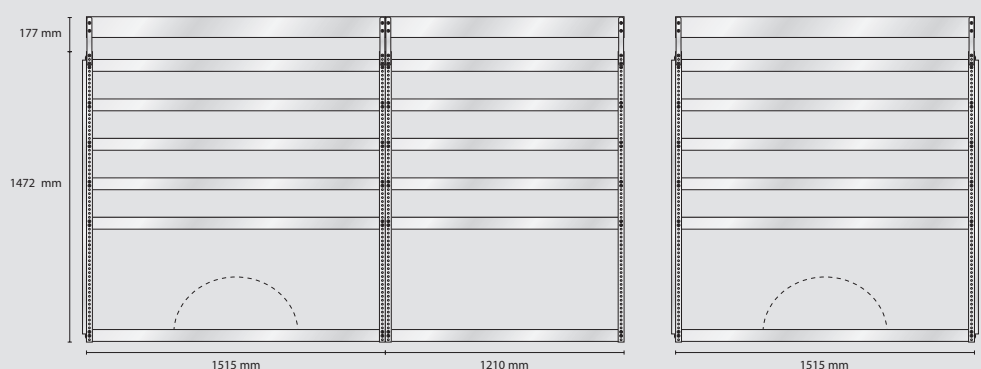

Unassembled EAN: 188135  
Assembled EAN: 184137

Unassembled EAN: 188425  
Assembled EAN: 184427

Unassembled EAN: 188159  
Assembled EAN: 184151

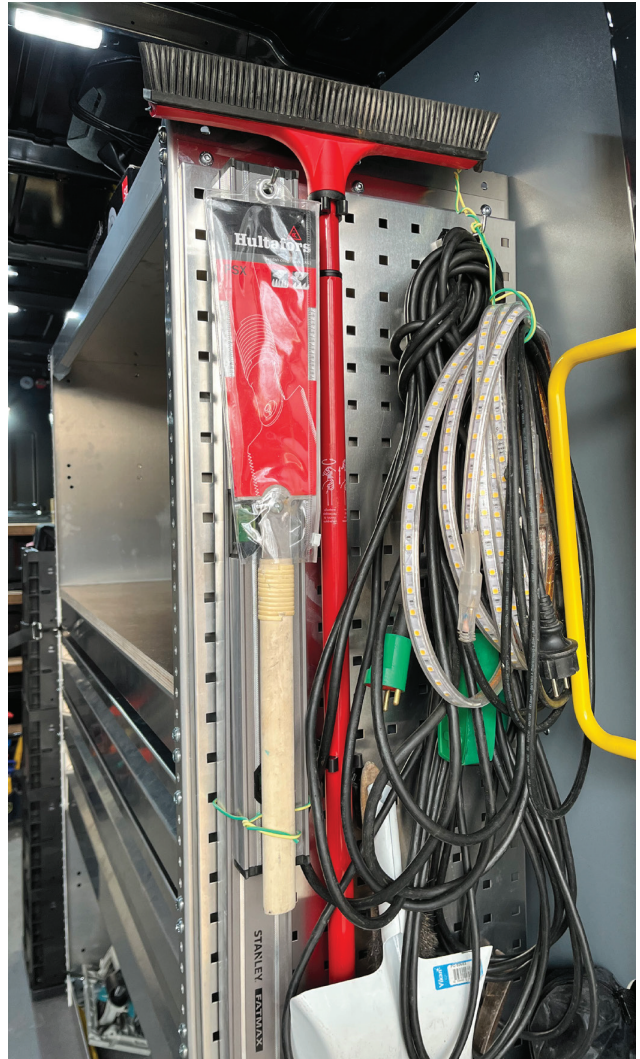

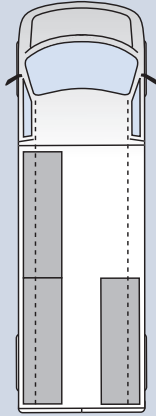

### The shelving position in the van

The depth of all modules is 380 mm.  
Adjustment of end walls may be necessary.

### Fits the following model

- Mercedes Sprinter L2/H1

## MODEL AS23 – alternative

Unassembled EAN: 186582

Assembled EAN: 182584

Content: 10 pcs. Shelf bin 4-800  
32 pcs. Shelf bin 5-600  
24 pcs. Shelf bin 6-1100  
10 pcs. Shelf bin 8-2000  
3 pcs. Perforated panels

Total weight: 133,2 kg

**S91** weight 42,9 kg

**S100** weight 50 kg

**S145** weight 40,6 kg

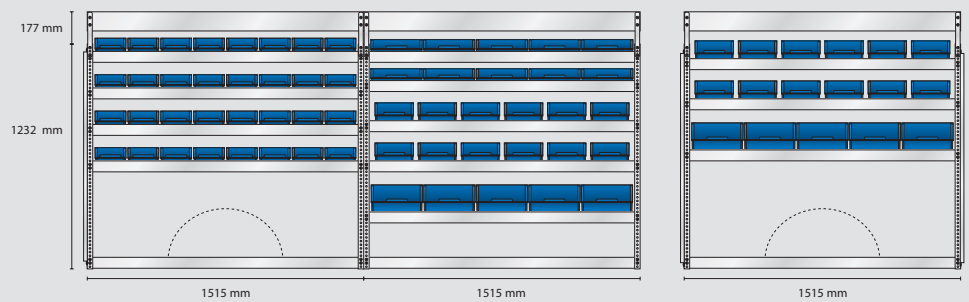

Unassembled EAN: 187909

Assembled EAN: 183901

Unassembled EAN: 187992

Assembled EAN: 183994

Unassembled EAN: 188418

Assembled EAN: 184410

## MODEL AS24 – alternative

Unassembled EAN: 186599

Assembled EAN: 182591

Content: 3 pcs. Perforated panels

Total weight: 93,5 kg

**S101** weight 30,1 kg

**S102** weight 31,8 kg

**S103** weight 31,9 kg

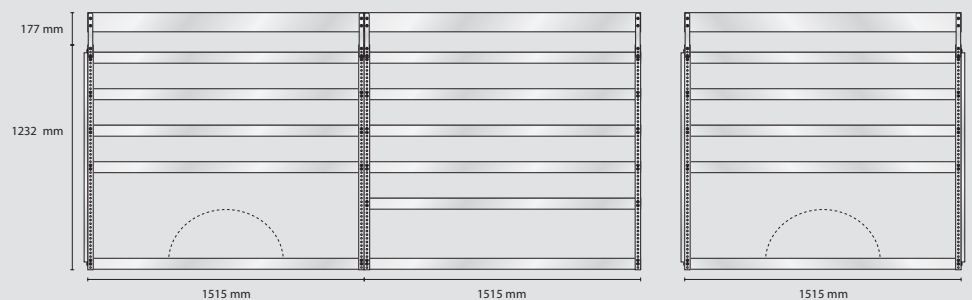

Unassembled EAN: 188432

Assembled EAN: 184434

Unassembled EAN: 188449

Assembled EAN: 184441

Unassembled EAN: 188005

Assembled EAN: 184007



## MODEL SS12 – standard

Unassembled EAN: 186551

Assembled EAN: 182553

Content: 48 pcs. Shelf bin 5-600  
18 pcs. Shelf bin 6-1100  
15 pcs. Shelf bin 8-2000  
2 pcs. Perforated panels

Total weight: 133,2 kg

**S144** weight 44,7 kg

**S92** weight 44,1 kg

**S93** weight 44,7 kg

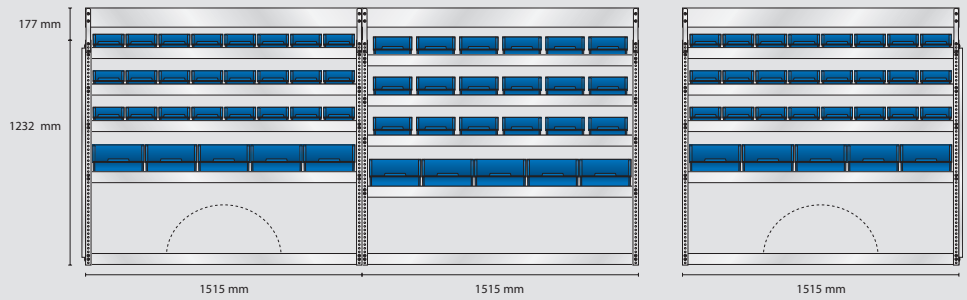

Unassembled EAN: 188401

Assembled EAN: 184403

Unassembled EAN: 187916

Assembled EAN: 183918

Unassembled EAN: 187923

Assembled EAN: 183925

## MODEL ES12 – electrician

Unassembled EAN: 186568

Assembled EAN: 182560

Content: 40 pcs. Shelf bin 4-800  
18 pcs. Shelf bin 5-600  
5 pcs. Shelf bin 8-2000  
6 pcs. CarryLite 80-15  
2 pcs. Perforated panels

Total weight: 138,7 kg

**S94** weight 48,1 kg

**S95** weight 46,8 kg

**S96** weight 44,1 kg

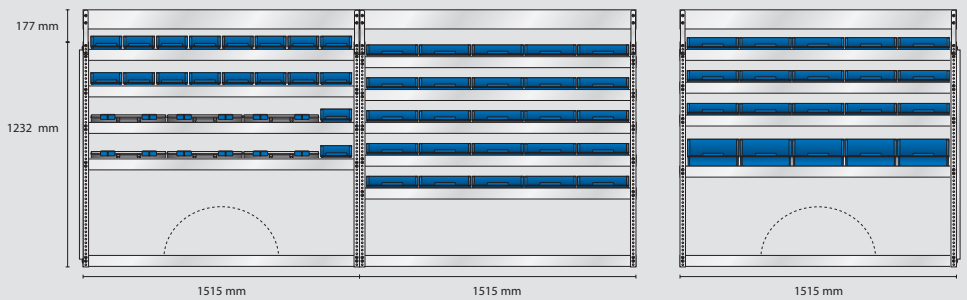

Unassembled EAN: 187930

Assembled EAN: 183932

Unassembled EAN: 187947

Assembled EAN: 183949

Unassembled EAN: 187954

Assembled EAN: 183956

## MODEL VS12 – plumber

Unassembled EAN: 186575

Assembled EAN: 182577

Content: 50 pcs. Shelf bin 4-800  
2 pcs. Shelf bin 5-600  
5 pcs. Shelf bin 8-2000  
6 pcs. CarryLite 80-15  
2 pcs. Perforated panels

Total weight: 138,3 kg

**S97** weight 42,1 kg

**S98** weight 52,4 kg

**S96** weight 44,1 kg

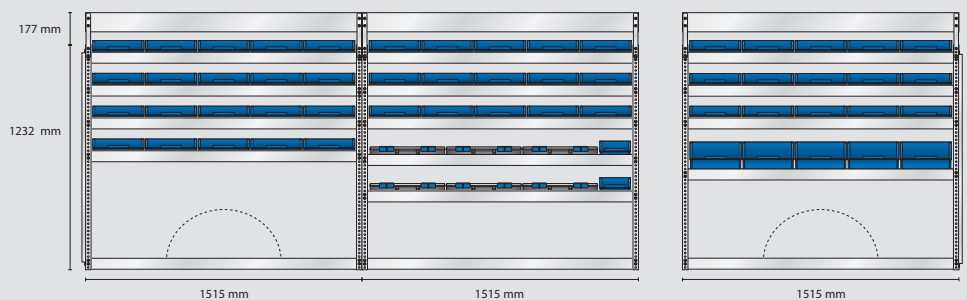

Unassembled EAN: 187961

Assembled EAN: 183963

Unassembled EAN: 187978

Assembled EAN: 183970

Unassembled EAN: 187954

Assembled EAN: 183956

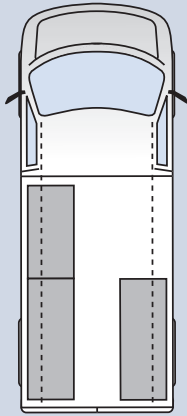

### The shelving position in the van

The depth of all modules is 380 mm.  
Adjustment of end walls may be necessary.

### Fits the following models

- Citroen Jumper L3/H2
- Fiat Ducato L3/H2
- Iveco Daily 12m3 L3/H2
- Mercedes Sprinter L2/H2
- Nissan Interstar L3/H2
- Opel Movano L3/H2
- Peugeot Boxer L3/H2
- Renault Master L3/H2
- Renault Master L3/H3

## MODEL AS25 – alternative

Unassembled EAN: 186636  
Assembled EAN: 182638

Content: 10 pcs. Shelf bin 4-800  
40 pcs. Shelf bin 5-600  
24 pcs. Shelf bin 6-1100  
20 pcs. Shelf bin 8-2000  
3 pcs. Perforated panels

Total weight: 161,1 kg

**S104** weight 51 kg

**S114** weight 59,9 kg

**S115** weight 50,5 kg

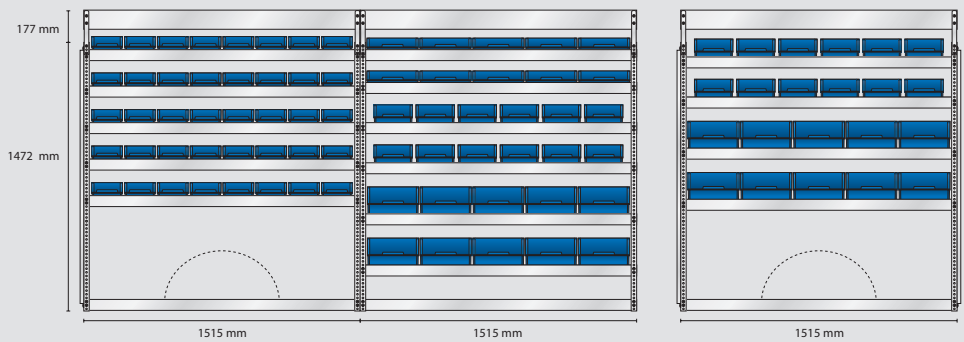

Unassembled EAN: 188012  
Assembled EAN: 184014

Unassembled EAN: 188111  
Assembled EAN: 184113

Unassembled EAN: 188128  
Assembled EAN: 184120

## MODEL AS26 – alternative

Unassembled EAN: 186643  
Assembled EAN: 182645

Content: 3 pcs. Perforated panels

Total weight: 108,2 kg

**S116** weight 35 kg

**S117** weight 36,7 kg

**S118** weight 36,8 kg

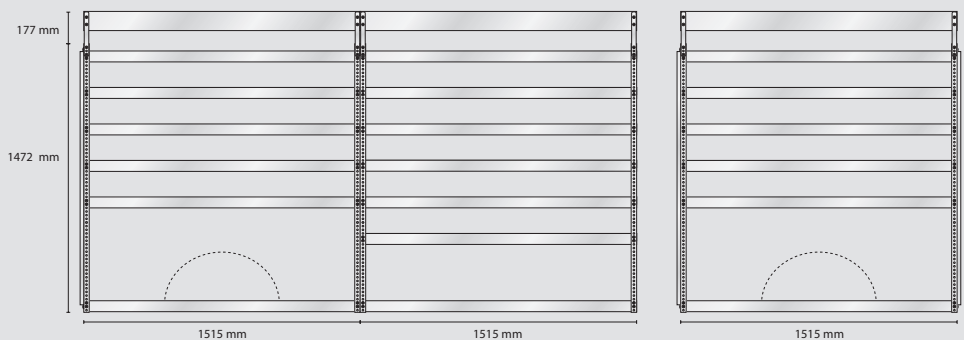

Unassembled EAN: 188135  
Assembled EAN: 184137

Unassembled EAN: 188142  
Assembled EAN: 184144

Unassembled EAN: 188159  
Assembled EAN: 184151

## MODEL SS13 – standard

Unassembled EAN: 186605  
 Assembled EAN: 182607

Content: 64 pcs. Shelf bin 5-600  
 18 pcs. Shelf bin 6-1100  
 20 pcs. Shelf bin 8-2000  
 2 pcs. Perforated panels

Total weight: 159,3 kg

**S104** weight 51 kg

**S105** weight 54 kg

**S106** weight 54,6 kg

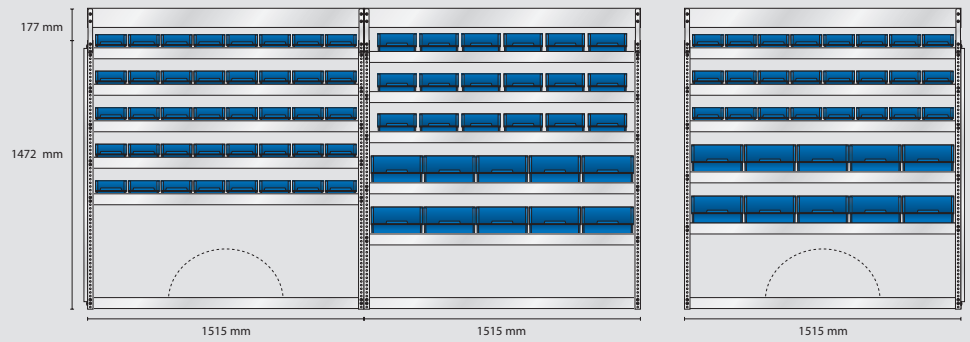

Unassembled EAN: 188012  
 Assembled EAN: 184104

Unassembled EAN: 188029  
 Assembled EAN: 184021

Unassembled EAN: 188036  
 Assembled EAN: 184038

## MODEL ES13 – electrician

Unassembled EAN: 186612  
 Assembled EAN: 182614

Content: 35 pcs. Shelf bin 4-800  
 26 pcs. Shelf bin 5-600  
 12 pcs. Shelf bin 6-1100  
 5 pcs. Shelf bin 8-2000  
 6 pcs. CarryLite 80-15  
 2 pcs. Perforated panels

Total weight: 157,3 kg

**S107** weight 56,2 kg

**S108** weight 48,2 kg

**S109** weight 53,2 kg

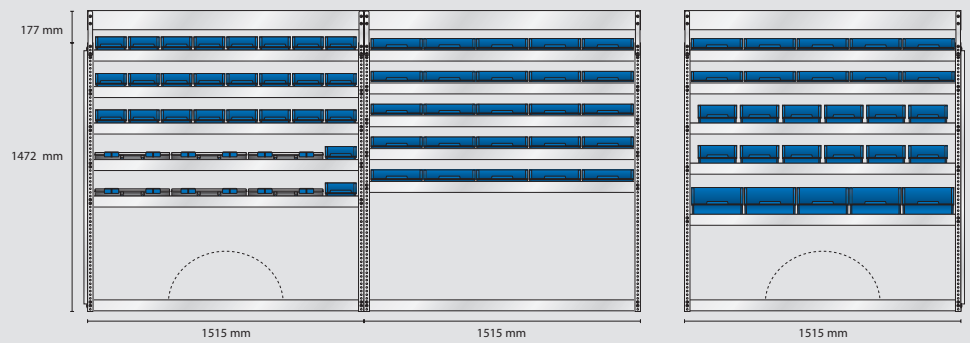

Unassembled EAN: 188043  
 Assembled EAN: 184045

Unassembled EAN: 188050  
 Assembled EAN: 184052

Unassembled EAN: 188067  
 Assembled EAN: 184069

## MODEL VS13 – plumber

Unassembled EAN: 186629  
 Assembled EAN: 182621

Content: 50 pcs. Shelf bin 4-800  
 2 pcs. Shelf bin 5-600  
 10 pcs. Shelf bin 8-2000  
 6 pcs. CarryLite 80-15  
 2 pcs. Perforated panels

Total weight: 151 kg

**S110** weight 50 kg

**S111** weight 53,8 kg

**S112** weight 47,5 kg

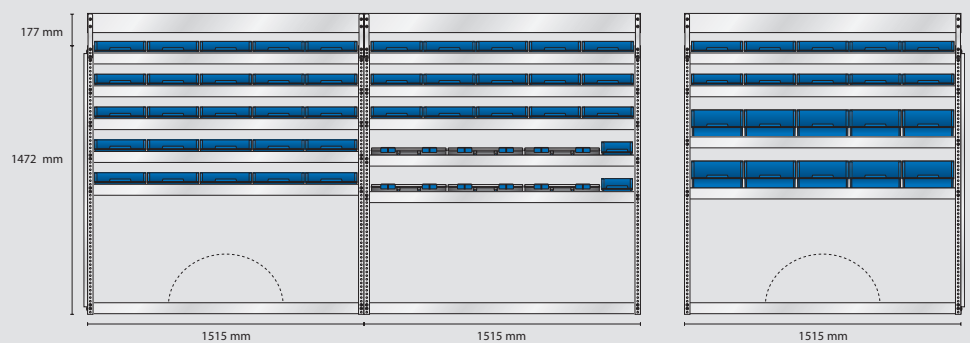

Unassembled EAN: 188074  
 Assembled EAN: 184076

Unassembled EAN: 188081  
 Assembled EAN: 184083

Unassembled EAN: 188098  
 Assembled EAN: 184090

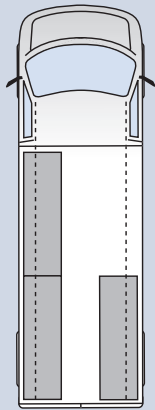

### The shelving position in the van

The depth of all modules is 380 mm.  
Adjustment of end walls may be necessary.

### Fits the following models

- Iveco Daily 13,4m<sup>3</sup> L3/H3
- Opel Movano L3/H3

### MODEL AS31 – alternative

Unassembled EAN: 188777

Assembled EAN: 188784

Content: 15 pcs. Shelf bin 4-800  
48 pcs. Shelf bin 5-600  
30 pcs. Shelf bin 6-1100  
15 pcs. Shelf bin 8-2000  
3 pcs. Perforated panels

Total weight: 175,2 kg

**S193** weight 57,6 kg

**S194** weight 59,1 kg

**S195** weight 58,8 kg

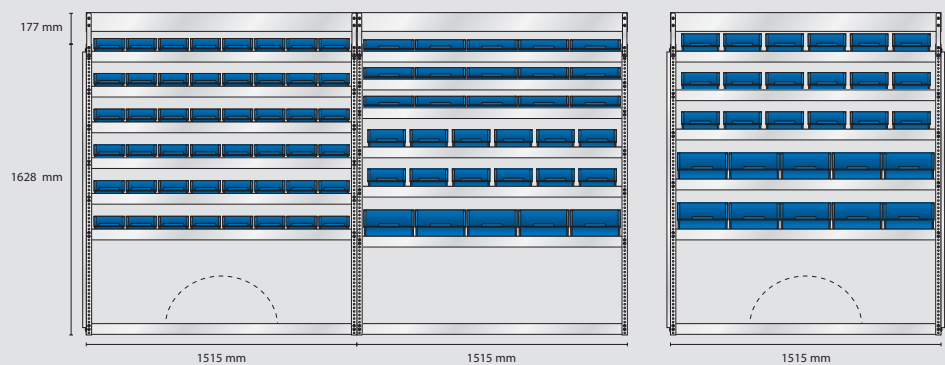

Unassembled EAN: 188715

Assembled EAN: 188722

Unassembled EAN: 188739

Assembled EAN: 188746

Unassembled EAN: 188753

Assembled EAN: 188760

### MODEL AS32 – alternative

Unassembled EAN: 188852

Assembled EAN: 188869

Content: 3 pcs. Perforated panels

Total weight: 118,8 kg

**S196** weight 39,7 kg

**S197** weight 37,9 kg

**S198** weight 41,5 kg

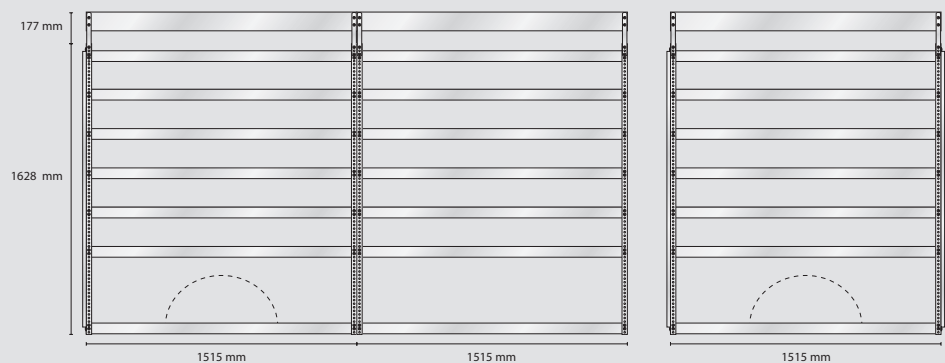

Unassembled EAN: 188791

Assembled EAN: 188807

Unassembled EAN: 188814

Assembled EAN: 188821

Unassembled EAN: 188838

Assembled EAN: 188845

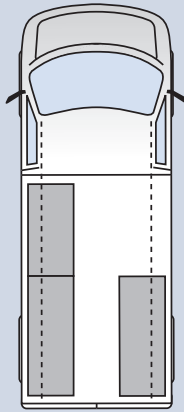

### The shelving position in the van

The depth of all modules is 380 mm.

Adjustment of end walls may be necessary.

### Fits the following models

- Mercedes Sprinter L3/H2
- Volkswagen Crafter L4/H3
- Mercedes Sprinter L4/H2
- Volkswagen Crafter L5/H3

## MODEL AS33 – alternative

Unassembled EAN: 188876

Assembled EAN: 188883

Content: 9 pcs. Shelf bin 4-800  
 70 pcs. Shelf bin 5-600  
 10 pcs. Shelf bin 6-1100<sup>972 mm</sup>  
 14 pcs. Shelf bin 8-2000  
 2 pcs. Perforated panels

Total weight: 185,6 kg

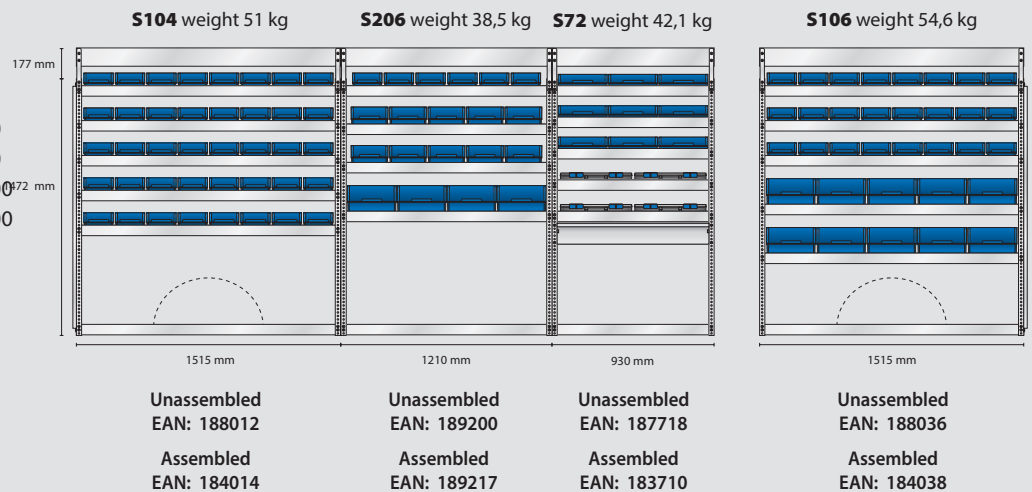

## MODEL AS34 – alternative

Unassembled EAN: 188890

Assembled EAN: 188906

Content: 3 pcs. Perforated panels

Total weight: 124,7 kg

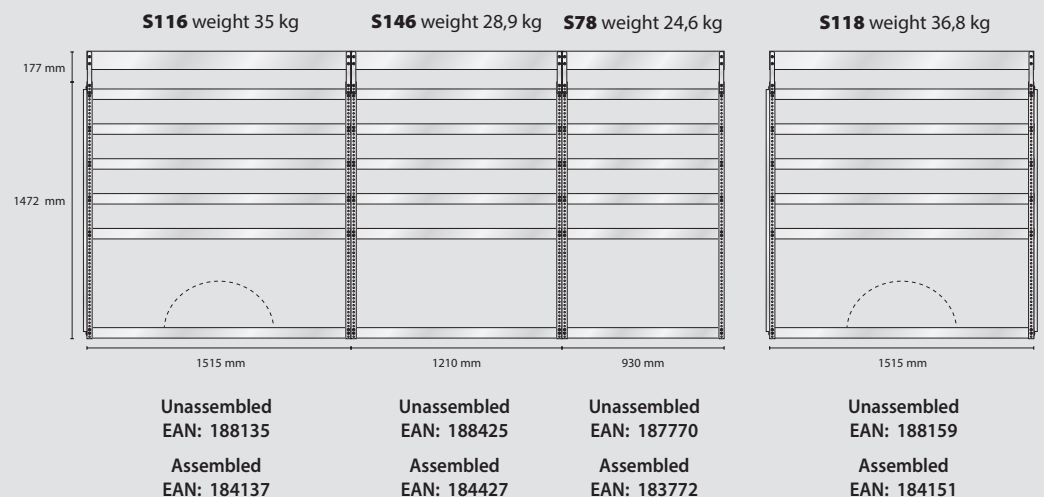

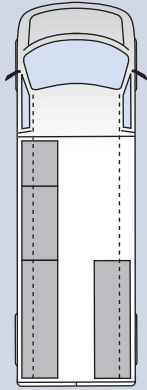

### The shelving position in the van

The depth of all modules is 380 mm.  
Adjustment of end walls may be necessary.

### Fits the following models

- Ford Transit 2T L4/H3
- Mercedes Sprinter L3/H3
- MAN TGE L4/H3
- Mercedes Sprinter L4/H3
- MAN TGE L5/H3

### MODEL AS35 – alternative

Unassembled EAN: 188951  
Assembled EAN: 188968

Content: 12 pcs. Shelf bin 4-800  
48 pcs. Shelf bin 5-600  
40 pcs. Shelf bin 6-1100  
16 pcs. Shelf bin 8-2000  
1 pcs. Alu drawer  
3 pcs. Perforated panels

Total weight: 203,5 kg

**S193** weight 57,6 kg

**S199** weight 48,7 kg

**S200** weight 39 kg

**S195** weight 58,8 kg

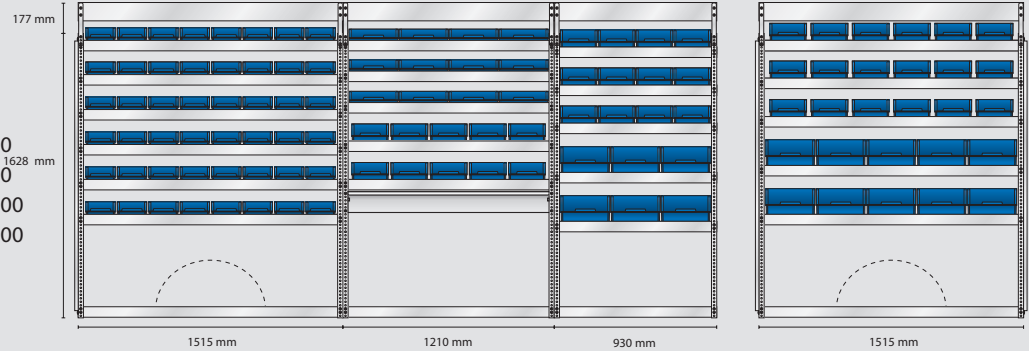

Unassembled  
EAN: 188715

Assembled  
EAN: 188722

Unassembled  
EAN: 188913

Assembled  
EAN: 188920

Unassembled  
EAN: 188937

Assembled  
EAN: 188944

Unassembled  
EAN: 188753

Assembled  
EAN: 188760

### MODEL AS36 – alternative

Unassembled EAN: 189019  
Assembled EAN: 189026

Content: 3 pcs. Perforated panels

Total weight: 143,5 kg

**S196** weight 39,7 kg

**S201** weight 32,9 kg

**S202** weight 30 kg

**S198** weight 41,5 kg

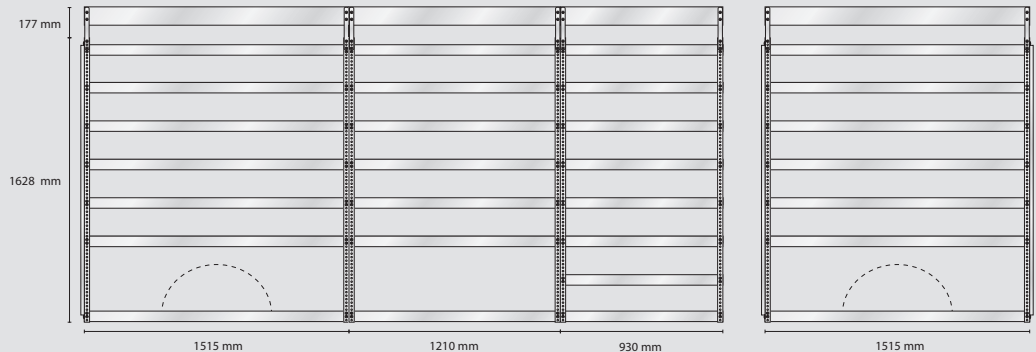

Unassembled  
EAN: 188791

Assembled  
EAN: 188807

Unassembled  
EAN: 188975

Assembled  
EAN: 188982

Unassembled  
EAN: 188999

Assembled  
EAN: 189002

Unassembled  
EAN: 188838

Assembled  
EAN: 188845



# MODULES FOR SCREWS AND NAILS

## MODEL S178 – Shelving for screws

Unassembled  
EAN: 188579

Content: 4 pcs. Angled shelves  
2 pcs. End walls

Assembled  
EAN: 184571

1 pcs. Bottom angle  
1 pcs. Perforated panel

Total weight: 18,3 kg

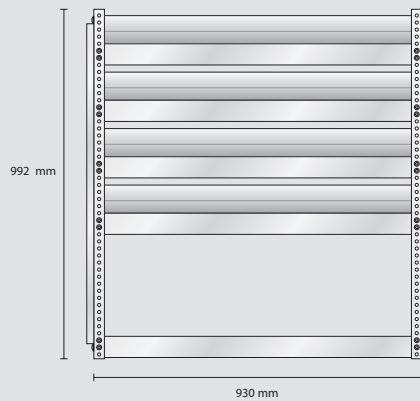

## MODEL S179 – Shelving for screws

Unassembled  
EAN: 188586

Content: 5 pcs. Angled shelves  
2 pcs. End walls

Assembled EAN: 184588

1 pcs. Bottom angle  
1 pcs. Perforated panel

Total weight: 26,1 kg

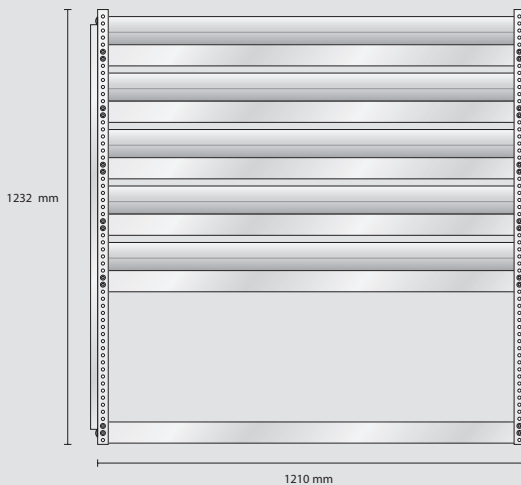



# SHELVING FOR BOXXSER



992 mm

486 mm

## MODEL S217 – Boxxser shelving

Unassembled  
EAN: 189378

Assembled  
EAN: 189392

Content:  
2 pcs. Boxxser 55 5x10-25  
5 pcs. Boxxser 80 5x10-14  
7 sets Rails

Total weight: 25,8 kg



992 mm

486 mm

## MODEL S216 – Boxxser shelving

Unassembled  
EAN: 189361

Assembled  
EAN: 189385

Content:  
7 sets Rails

Total weight: 12,2 kg



# SHELVING FOR CARRYLITE



992 mm

486 mm

## MODEL S295 – CarryLite shelving

Assembled  
EAN: 190053

Content:  
1 pcs. CarryLite 55-25/2  
5 pcs. CarryLite 80-15  
1 pcs. CarryLite 150-9  
7 sets Rails

Total weight: 25,6 kg

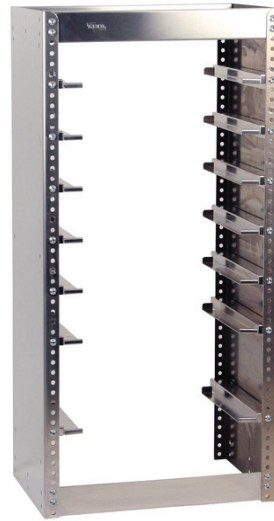

992 mm

486 mm

## MODEL S192 – CarryLite shelving

Unassembled  
EAN: 185745

Assembled  
EAN: 184656

Content:  
7 sets Rails

Total weight: 12,1 kg



992 mm

486 mm

## MODEL S294 – CarryLite shelving

Assembled  
EAN: 190046

Content:  
5 pcs. CarryLite 150-9  
5 sets Rails

Total weight: 19,0 kg

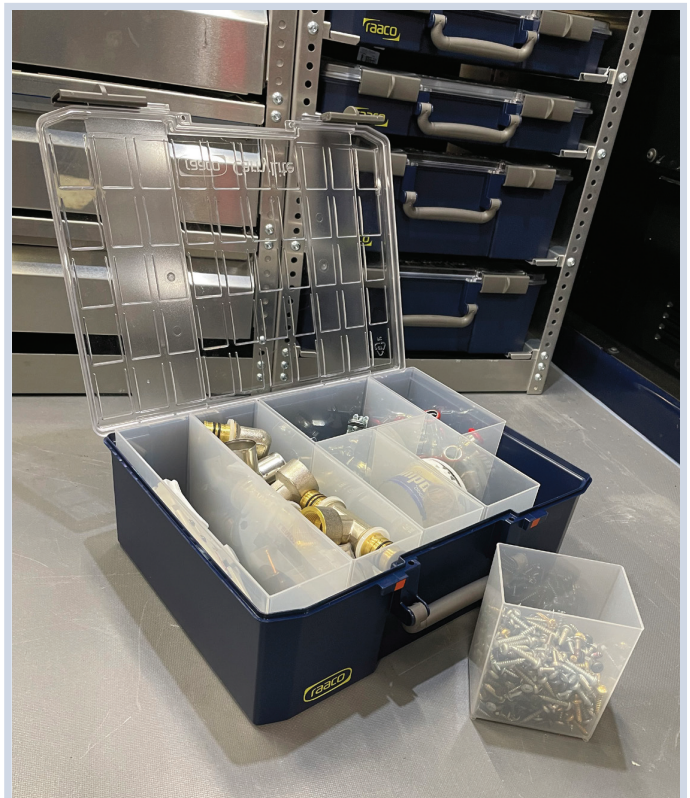

# SHELVING FOR CARRYLITE



992 mm

**MODEL S297  
– CarryLite shelving**

Assembled  
EAN: 190121

Content:  
4 pcs. CarryLite 80-15  
3 pcs. CarryLite 150-9  
7 sets Rails

Total weight: 26,3 kg

486 mm



992 mm

**MODEL S296  
– shelving**

Assembled  
EAN: 190107

Content:  
3 pcs. Alu drawers, low  
3 pcs. Alu drawers, deep

Total weight: 40,18 kg

486 mm



992 mm

**MODEL S298  
– CarryLite shelving**

Assembled  
EAN: 190114

Content:  
8 pcs. CarryLite 80-15  
8 sets Rails

Total weight: 29,5 kg

486 mm



992 mm

**MODEL S299  
– CarryLite shelving**

Assembled  
EAN: 190091

Content:  
4 pcs. CarryLite 55-25/2  
5 pcs. CarryLite 80-15  
9 sets Rails

Total weight: 31,13 kg

486 mm

# ACCESSORIES



## TOOL WALL PANELS AND ACCESORIES

SuperClip and holders so you can create manageable storage solutions for tools, accessories and much more.

- |    |        |  |
|----|--------|--|
| 1  | 121545 | Clipset 81 (81 ass. clips)                       |
| 2  | 121538 | Clipset 51 (51 ass. clips)                       |
| 3  | 100526 | Clipset 14 (14 ass. clips)                       |
| 4  | 108928 | Clip 10 (4 pcs.)                                 |
| 5  | 471220 | Hook for bag                                     |
| 6  | 472104 | Can holder for 3 cans                            |
| 7  | 471176 | Angle grinder holder                             |
| 8  | 470728 | Cable holder                                     |
| 9  | 136839 | raacoFix, Small                                  |
| 10 | 136822 | raacoFix, Large                                  |
| 11 | 475266 | Can holder                                       |
|    | 471275 | Tool wall panel for shelving side panel, 900 mm  |
|    | 470551 | Tool wall panel for shelving side panel, 992 mm  |
|    | 470568 | Tool wall panel for shelving side panel, 1232 mm |

## ACCESSORIES FOR TOP BOX

- |    |        |   |
|----|--------|---|
| 12 | 471114 | U-profil for top box                        |
| 13 | 136662 | Bin 5-460 for top box, HxBxD=126x125x300 mm |
| 14 | 472005 | An opening flap for top box                 |

## ACCESORIES FOR ALU DRAWER

- |    |        |  |
|----|--------|--|
| 15 | 470940 | Divider for alu drawer                       |
| 16 | 185257 | Set of inserts: 8xBA6-1 + 16xBA7-1 + 9xBA8-3 |



### ACCESSORIES FOR BIN 4-800

The bin can be divided using dividers and can be fixed with a front plate and label.

- 17 107617 4-800 divider, large, 12 pcs./bag
- 18 108003 4-800 divider, medium, 24 pcs./bag
- 19 108010 4-800 divider, small, 36 pcs./bag
- 20 107600 4-800 front plate/label, 6 pcs./bag

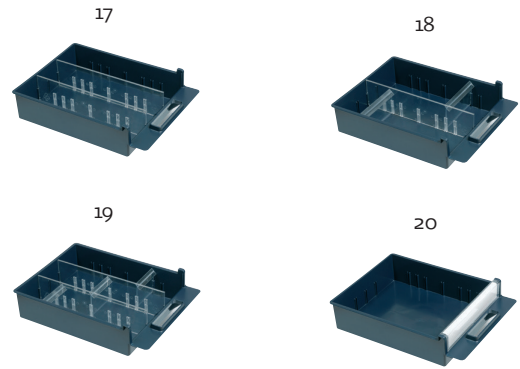

### OTHER ACCESSORIES

- 21 470780 Vice holder
- 22 475228 Ladder holder
- 23 472128 Document holder, end wall

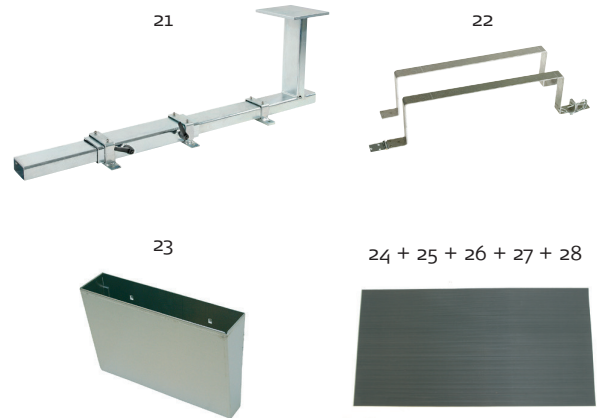

### RUBBERMATS FOR SHELVES

Non-slip and silencer.

- 24 475303 Rubbermat, 630 mm
- 25 475310 Rubbermat, 930 mm
- 26 475327 Rubbermat, 1070 mm
- 27 475334 Rubbermat, 1210 mm
- 28 475341 Rubbermat, 1515 mm

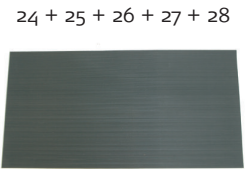

## Certified since 1994!

raaco A/S is a Danish-owned company known for traditions of innovative design, durable and sustainable products of high quality.

As a production company located at Lolland-Falster in Denmark, we are very aware of our impact on the environment around us.

We continuously work to reduce our emissions to air, water and soil.

In order to ensure constant high quality of our products, it was obvious to get certified in ISO 9001 in 1994 and our respect for the environment was confirmed by certification in ISO 14001 in 1999.

Certification in ISO 45001 with ISO 45003 in 2019/2021 was a logical extension of our mission to produce quality products in a sustainable environment with respect for our surroundings and employees.



## Limit TCO and make your working day easy and efficient!

With raaco van equipment, we offer you a customized solution for your van based on the needs you have in your working day. At the same time, we ensure you a low TCO.

raaco van equipment consists of modules and accessories produced in robust and durable materials - all made in Denmark!

We help you to create order, get an overview of your tools, work materials and accessories, so that you can easily and efficiently solve your work tasks at your customers.



### Flexibility and security

- ✓ **Overview** - Save time and increase your efficiency
- ✓ **Flexible** - Easy to adapt the equipment, if your needs change
- ✓ **Crash test** - TÜV certified which means security for you if an accident happens
- ✓ **Low weight** - Produced in aluminium, it therefore minimally affects the payload of your van

Let us find a solution for you - and optimize your working day!  
Contact our Sales for further information

Gareth John, General Sales Manager  
Tel: +44 7919151687  
E-mail: gj@raaco.com

Simon Copperwheat, Key Account Manager  
Tel: +44 7585606961  
E-mail: sc@raaco.com



## THE GLOBAL

For Sustainable Development



3 GOOD HEALTH AND WELL-BEING



9 INDUSTRY, INNOVATION AND INFRASTRUCTURE



12 RESPONSIBLE CONSUMPTION AND PRODUCTION

Since 1956, raaco has developed and manufactured innovative and durable storage systems, which are designed for order and overview - this saves time, space and money.

With a wide range of mobile and stationary storage systems and, where products can be used across systems, it helps to create a more efficient working day for professional craftsmen.

raaco has its own production in Denmark and supports the principles of UN Global Goals. The company works continuously on various environmental projects with focus on:

3 › Good health and well-being

9 › Industry, Innovation and Infrastructure

12 › Responsible consumption and production





Professional storage systems since 1956



Supplied by:-

Royal Tool Control Ltd.  
Amberley Court, Bold Street  
Sheffield, UK, S9 2LQ  
+44(0)114 2441411  
[www.royaltool.co.uk](http://www.royaltool.co.uk)



raaco Great Britain Ltd. • Wenrisc House, Meadow Court • High Street, Witney • GB-Oxon OX28 6ER  
[www.raaco.com](http://www.raaco.com)

Royal Tool Control Ltd. - +44 (0)114 2441411 – [sales@royaltool.co.uk](mailto:sales@royaltool.co.uk) – [www.royaltool.co.uk](http://www.royaltool.co.uk)